

FOR THE  
**AMSTRAD**  
PCW 8256-8512

**8000  
PLUS**

ISSUE 7 • APRIL 1987 • £1.25

**EK! IT'S  
A MOUSE!**



*This rodent could become  
your right hand man*

# Spreadsheets

Discover the secret of cutting through your paperwork

The LocoScript story • Cavalier business package reviewed • Win a PCW cabinet set



# What's so special about the Mac, the Atari St, The Amiga, Windows and Gem?

It's no surprise that nearly all new 16 bit 'state of the art' micros now come with a Mouse and Wimp environment (Windows, Icons, Menus and Pointers) as standard.

With the AMSTRAD PCW you already own one of the classic micros and by simply adding the AMX Mouse and Desktop you can achieve the same ease of use, freedom and versatility of much more sophisticated computers.

The AMX Mouse and compatible software – it's what you and your AMSTRAD micro have been missing.



**AMX MOUSE PACKAGE 3" DISC £79.95**

There's not much joy in a joystick and keyboards can be all fingers and thumbs. Acclaimed by the press as 'the best input device', already over 50,000 micro users have adopted an AMX Mouse. No more complicated CP/M commands to remember, with the AMX Mouse you just point and click, even the experts find this system more efficient. Available for the Amstrad PCW 8256 & 8512.

## GRAPHIC FRONT END



Provides an easy to use graphic based front end to your computers disc filing system including a comprehensive set of disc management operations such as cataloging, coping, deleting, re-naming and formatting. There's no need to enter a command to run programs from disc, just point the mouse at the representing icon and click the button.

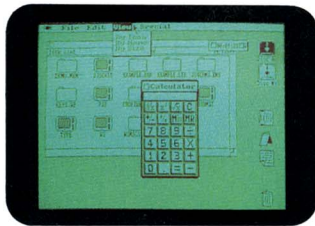

## TELEPHONE ADDRESS BOOK



A central place to store all your important names, addresses and telephone numbers.

A database type search facility allows you to enter any part of the information such as a persons' name, company name, town etc and instantly see the matching entry.



## DESK DIARY



A versatile appointments diary allowing you up to seven lines to be entered for any day. Printing facilities allow yearly and monthly summaries to be produced indicating days for which an entry has been indicated.

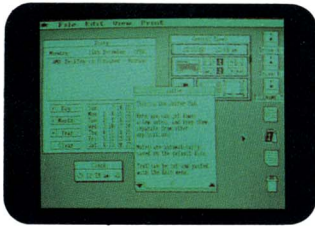

## MEMO PAD



This allows anything from a quick memo to a complete multi-page report to be produced from the Desktop. Many word processing features are included such as centering, justification, cut, copy and paste etc.

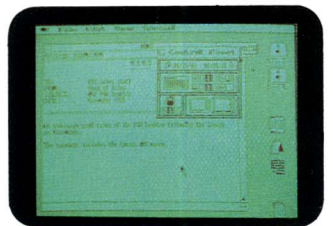

## DESK ACCESSORIES



The AMX Mouse package also includes a number of extra functions which are available for use at all times from the desktop. These include a jotter, alarm clock, calculator, puzzle and control panel – the type of tools found on a real desk top!

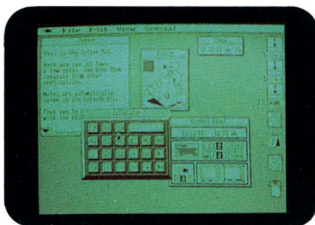

## STOP PRESS... STOP PRESS...

There will be a growing list of further mouse compatible software for the Amstrad PCW from AMS and other leading software houses in the coming months including Graphic and Desktop publishing programs.

This superb product is available now from all good computer dealers or direct by cheque, Access or Visa. All prices include VAT and post and packaging.



FOR INSTANT ACCESS/VISA ORDERS TELEPHONE (0925) 413501/2/3



# AMX SOFTWARE

IMAGINATION AT YOUR FINGERTIPS

ADVANCED MEMORY SYSTEMS LTD. 166/170 WILDERSPOOL CAUSEWAY, WARRINGTON, WA4 6QA. TELEX 628672 AMSG. FAX 0925 58039.

TUBELINK ON PRESTEL PAGE 2582182 SUPPORTS THE AMX MOUSE AND ALL AMS SOFTWARE

Macintosh is a licenced trade mark of Apple Inc. Atari St. is a trade mark of Atari Inc. Amiga is a trade mark of Commodore Business Machines Inc. Windows is a trade mark of Microsoft Inc. Gem is a trade mark of Digital Research Inc.



FUTURE PUBLISHING LTD  
THE OLD BARN  
SOMERTON  
SOMERSET • TALL 7PY  
TEL • 0458 74080

Telecom Gold • 84:TXT152

#### YOUR CONTACTS

EDITOR • BEN TAYLOR

ASSISTANT EDITOR • ALEC RAE

ADVERTISING • ANNE DEANEY

AD PRODUCTION • DIANE TAVERNER

DESIGN • DEAN WILSON

SUBSCRIPTIONS • CARRIE-ANNE PORTER

PUBLISHER • CHRIS ANDERSON

#### COVER PHOTOGRAPHY

ANTHONY SPINKS ABIPP AMPA  
STUDIO SEVENTY  
BOW STREET • LANGPORT  
SOMERSET  
TEL • 0458 250807

#### COLOUR ORIGINATION

WESSEX REPRODUCTION  
325A WELLS ROAD  
BRISTOL • BS4 0QL

#### PRINTING

REDWOOD WEB OFFSET  
YEOMANS WAY  
TROWBRIDGE • WILTS

#### DISTRIBUTION

SEYMOUR PRESS  
334 BRIXTON ROAD  
LONDON • SW9 7AG

© FUTURE PUBLISHING LTD 1987  
8000 Plus is an independent publication. The company who produce it - Future Publishing Ltd - have no link with Amstrad plc.  
We welcome contributions from readers, but unfortunately we cannot guarantee to return material submitted to us, nor can we enter into personal correspondence.  
We take great care to ensure that what we publish is accurate, but we cannot accept liability for any mistakes or omissions. No part of this publication may be reproduced in any form without our permission.

# OPENING MENU

## OPENING MENU

AmazInG News  
StunninG Features  
kNockout Reviews  
InValuable Tips  
SiZZling Offers

## 5 KEY WORDS

This month's burning topics of debate.

## 6 NEWS PLUS

Who, what, where and why. Now you know.

## 10 SIZZLING SPREADSHEETS

Learn what spreadsheets can do for you, and which are the best ones.

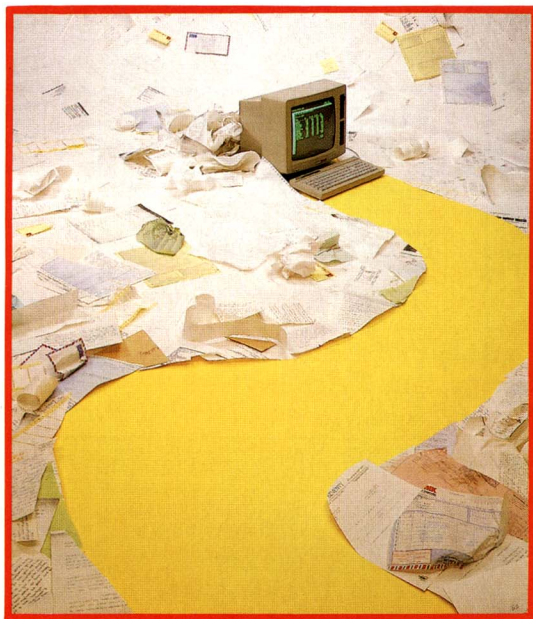

## 15 LOCO-COMMOTION

Things going wrong in LocoScript? Preposterous!

## 19 MOUSEY, MOUSEY

Kempston's mouse shows the way for others.

## 20 SUPERCALC SURPRISE

A 2-page bonanza for SuperCalc users.

## 23 THE LOCOSCRIPT STORY

The faces and forces behind LocoScript.

## 25 MAKE YOUR FIRST MILLION

Software to play the stock market.

## 29 I SPY WITH MY LITTLE PCW

Unveiling CP/M's file security features.

## 32 CASE IN POINT

How David Gladden's PCW took a school by storm.

## 34 ACCOUNTING-FOR TASTE

Cavalier wide-ranging accounts, stock control and database package is checked out.

## 38 CABINET COMPETITION

Win one of five superb PCW cabinet sets.



## 41 DIMINISHING RETURNS

Beat the taxman at his own game with Personal Tax Planner.

## 42 GAME FOR A LAUGH

Family fun for football fans, and other new games.

## 44 BASICALLY SPEAKING

The penultimate part of John Hughes' BASIC tutorial.

## 48 LANGFORD'S PRINTOUT

Alcoholic author Dave Langford imparts more wisdom.

## 51 DO YOURSELF A FAVOUR

The way you work could be damaging your health.

## 52 QUICKIES

The secrets of beautiful print - large and small.

## 56 LISTINGS PLUS

Whether you're a programmer or a real person, there's something here for everyone.

## 60 TIP-OFFS

Three pages written by you for you. You're so clever.

## 64 PUBLIC KNOWLEDGE

A stripped-down version of WordStar - absolutely free.

## 69 THE GOOD SOFTWARE FILE

Interested in spreadsheets, educational software or utility programs? This month's Guide gives out gold stars and rapped knuckles.

## 74 SPECIAL OFFERS

Cheap at twice the price, with love from 8000 Plus.

## 78 POST SCRIPT

As ever, you have the last word.



AT NABITCHI COMPUTING WE STILL MEAN BUSINESS ON YOUR PCW!

PCW8256 PCW8512 COMPUTERS

You Could Pay £1000 For A PC And Printer With Software.

We Only Charge For The PCW8256

£ 373.00 less vat  
Includes printer & software

And If You Think You Need More Power The PCW8512 Is Only

£ 469.00 less vat  
Software & Printer free

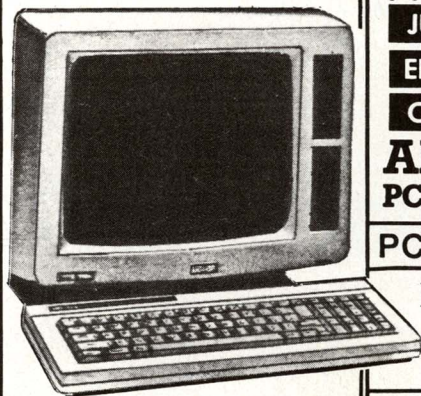

HARDWARE FOR YOUR PCW'S:-

PRINTERS

JUKI 6100 DAISYWHEEL £322.00 inc vat.

EPSON MATRIX FX105 £546.25 inc vat.

CANON LASER LBP8 £1900.00 +Vat

AMSTRAD DMP3000 £194.35 inc.vat  
PC Compatible Dot Matrix Printer

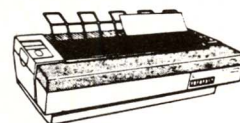

PCW8256 MEMORY UPGRADE

Full Kit Of Parts Only £22.00

plus vat

D.I.Y. In Less Than 15 mins



PCW8256 2nd DISK DRIVE

The Real 3 inch 1 Meg Amstrad FD2 2nd. Drive (just plug it in!) £120.00 plus vat

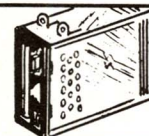

AMSTRAD CPS8256

CENTRONICS/SERIAL INTERFACE

Plugs Into Back Of PCW For Printers (Centronics Port) plus vat And Modems (RS232 Port) £52.00



PACE AMSTRAD MODEM

PC Phone Home! With A Modem On Your PCW £89.95 including vat



PCW PRINTER RIBBONS

We Stock Em! You Use Em! £4.17 Each (min. Order 2) plus vat



ELECTRIC STUDIO MOUSE

Mouse And Software Makes Artwork For PCW Easy! A Real Gem! £109.52 plus vat



CF2 3" DISKS

New Low Price!  
£29.95 For 10 plus £1 p & p inc. vat  
£16.00 For 5 plus £1 p & p inc. vat

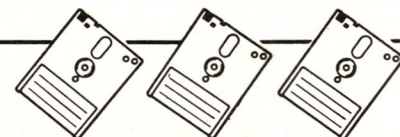

**NABITCHI COMPUTING**

Merseyside Innovation Centre

131 Mount Pleasant Liverpool L3 5TF  
Telephone 051-708 0123 / 051-708 8775



All prices are correct at time of going to press.

ATTENTION - ALL PCW OWNERS.

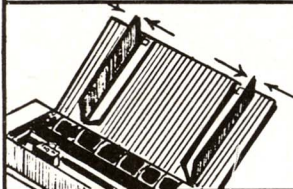

Our New Paper Guide Replace's The PCW's Paper Tray And Put's An End To Bad Paper Loading. Sheet Feeder £12.95 including vat

SOFTWARE (All software includes vat)

EXBASIC.....£11.45  
FASTLY BECOMING THE BEST KNOWN GRAPHICS UTILITY PROGRAM FOR MALLARD BASIC (SEE GRAPHICS WITHOUT THE PAIN A.P.C SEPTEMBER 1986) EXBASIC IS IDEAL FOR DRAWING PYE CHARTS/PLOTS/GRAPHS ECT. (SAMPLES ISSUED ON THE SAME DISK)

ITSBASIC.....£7.95  
FOR ADULTS ONLY! 20 MALLARD BASIC PROGRAMS WHICH WILL GUARANTEE HOURS OF FUN. WITH USEFULL PROGRAMS LIKE ADDRESS BOOK AND STICKY LABEL PRINTER. (SEE 8000 PLUS REVIEW FEB 87 "PIRATES TREASURE" FIVE STARS OF VALUE!)

LOCA-PRINTER..(SOFTWARE ONLY).....£29.95  
LOCA-PRINTER..(INTERFACE UNIT).....£21.95  
LOCA-PRINTER..(SOFTWARE/INTERFACE)..£49.95  
WORKS DIRECTLY FROM LOCOSCRIPT TO ANY CENTRONICS/SERIAL PRINTER. OUR INTERFACE PLUGS INTO THE PCW'S STANDED PRINTER SOCKET THUS SAVING YOU BUYING THE AMSTRAD CPS8256 INTERFACE. (IT ALSO SUPPORTS THAT IF YOU HAVE ONE ALREADY!) LOCA-PRINTER HAS LOTS OF NEW FEATURES SEND S.A.E FOR INFO.

WORDPROCESSING

POCKET WORDSTAR DELUXE.....£59.95  
POCKET WORDSTAR.....£39.95  
LOCOMAIL.....£35.95  
LOCOSPELL.....£35.95  
NEWWORD 2.....£59.95  
PROTEXT.....£69.95  
PROSPELL.....£25.95  
TASWORD 8000.....£19.95  
TAS-SPELL.....£15.50

ACCOUNTS

SAGE POPULAR ACCOUNTS.....£85.95  
SAGE POP/ACCOUNTS PLUS.....£125.95  
SAGE POP/ACC/SUP/COMBO.....£159.95  
SAGE POP/PAYROLL.....£53.95  
SAGE POP/INVOICING.....£53.95  
MONEY MANAGER.....£23.95  
MICRO SIMPLEX.....£89.95

SPREADSHEETS

SUPERCALC 2.....£38.95  
CRACKER 2.....£38.95  
MULTIPLAN.....£59.95  
SUPERCALC 3 (PC).....£69.00  
SCRATCH PAD PLUS.....£45.95  
POCKET CALCSTAR.....£45.95  
VP PLANNER.....£89.95

LANGUAGES

HISOFT C (PLUS EDITOR).....£35.95  
HISOFT PASCAL80.....£35.95  
HISOFT DEVPC 80 (ASM).....£35.95  
DR CBASIC COMPILER.....£42.95  
DR PASCAL MT+.....£42.95  
NEVADA COBOL.....£35.95  
ANSOFT FORTH.....£25.95

DATABASE

CONDOR 1.....£79.95  
dBASE II.....£95.95  
DELTA 1.25.....£79.95  
CARDBOX.....£48.95  
CAMBASE.....£48.95  
AT LAST.....£28.95  
FLEXIFILE.....£45.95  
SAGE RETRIEVE.....£59.95

GRAPHICS

DR DRAW.....£45.95  
DR GRAPH.....£45.95  
POLYPRINT.....£26.95  
POLYTYPE FACES (EACH).....£17.95  
PLOTYPLOT.....£22.95  
FULL POLY SERIES.....£49.95  
EXBASIC.....£11.45

send a S.A.E. for catalogue



## New faces at the Old Barn

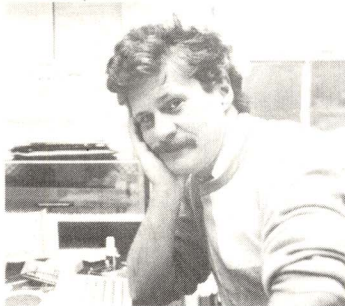

It seems that no editorial team is complete without a token Scotsman. Rather than break a tradition we have been joined by Alec Rae.

Alec's background is as a technical journalist for the construction industry, and after a short interlude running a hotel in Kintyre he bought a PCW to write his first novel on. From there, as they say, he's never looked back.

## PRINTER COMPETITION RESULTS

Good news for the Somerton postman – the 8000 Plus/Compumart printer competition is over. For the last six weeks, every post has brought more and more entries, until the final draw was made from a staggering pile of 3,000 postcards.

The winner, who receives a Juki 6100 daisywheel printer, a PCW Centronics interface, a connecting lead and a mains plug (we're so generous) is **C. Le Comte** of Southborne in Dorset. The correct answers were: FLOPPY DISC, DISKIT, LOCOSCRIPT, INTERFACE, MAILMERGE, DAISYWHEEL and DOT MATRIX.

We had a few noteworthy entries. One person, who shall remain nameless, actually got the answer wrong, and there were several people who pointed out on their entries that 'dot matrix' is two words not one. Unfortunately pedants don't win competitions.

Perhaps the best entry was on the final day: 40 postcards arrived, all in the same handwriting and all posted first class from Manchester. There was no rule against multiple entries, but unfortunately lady luck frowned on this tactic!

The 20 runners-up, who will receive a blank disc for their trouble, are:



"WE CAN'T PRINT OUT THE RESULTS - WE'VE GIVEN THE PRINTER AWAY!"

Mrs L.A. Courts, Truro; Miss M. Robinson, Nelson; Mrs M.V. Pearson, Cobham; Keith Irvine, Aylesbury; Mrs E. Christie, Aberdeen; Dr. L.A. Aziz, Woolwich; Mr. A.P. Barrington-Ward, Brighton; Mr. David Barber, Crewe; J. Denny, Birmingham; Ramli Mat Suki, Salford; W.R. Carr, Lasswade; R. Budd, Croydon; John Attfield, Bromley; Tony Gelder, North Watford; Ms G. Simmie, Furbo; Kemal Ahamed, Brentford Dock; V.W. Taylor, Wantage; Brian Hills, Oxford; Jane Stanton, Tottenham; Mr A.J. Robson, Felpham.

## UNBECOMING CONDUCT

Owners of Amstrad PCWs are not like anybody else the home computer industry has ever seen, and this simple fact is causing some problems.

In the past, 'hobby' users and 'business' users never spoke to each other. The software suppliers were different too – very few companies sold to both the hobby and business markets. Amateur enthusiasts would set up a mail order business running from home, and if they had the right product they would grow.

The Amstrad PCW changed the customer base dramatically. In the space of a few months, there was suddenly a large number of professional people – solicitors, company directors, writers – accustomed to 'business' style service, now with a computer which was vital to their work.

Since the big boys of business software were (at first) reluctant to cut prices to catch PCW owners, the traditionally hobby-oriented companies muscled in on the act. Most of them have done well in their new market, and have helped to bring the cost of computing crashing down. Unfortunately, it has to be said that some others have not done anything to dispel the image of the home computer industry as being run by bumbling amateurs.

For some reason, people seem to think that the various trading standards laws don't apply to software. Practices that would normally end up in court are accepted as normal. People can advertise a product they can't deliver; people can sell software that they know to be defective, and say "sorry, you get what you pay for"; people can decline to answer phones or reply to letters.

'Home' software costs a lot less than 'professional' software, so no-one expects to get the same level of after-sales support. But even so, consumer rights still hold good.

So come on, guys! The range and quality of software for the PCW makes it superb value for home and business use – let's keep standards of production and service at the high level that most companies do provide, and that the new breed of computer owners expect.

Ber Taylor

## The price is (not) right

The review of Campbell Systems 'Masterfile' in our last issue inadvertently carried an incorrect price. The correct figure is £49.95, not £59.95 as we stated. So it's even better value than we thought it was at first. Great.

The MAY issue of 8000 Plus will be on sale on THURSDAY APRIL 9th. Start queuing now, or you could miss out!



▲ The moment of truth in the printer competition.



## THE GREAT RIBBON DEBATE

The ribbon that comes with the PCW printer has a limited life, and many PCW owners have now had to buy new ones. However, the replacements seem to wear out much faster than the originals. Several readers have written suggesting all sorts of nefarious dealings and suggesting an "Amstrad ribbon rip-off scandal."

Following a flood of letters, our investigations have revealed an important difference – the original ribbon shipped inside the PCW packaging is made in Japan, the replacements are made in Britain.

Scientific tests in the 8000 Plus offices (actually taking the top off an original and a replacement and looking very hard) showed that there was a considerable difference in the amount of ribbon provided.

It seems that you can tell whether you are buying a long or a short ribbon without having to open up the case. There were differences in the casings – the long original ribbon had only one lug (a little black plastic handle sticking out of the front) set to the left, while the shorter replacements had two lugs.

The final breakthrough came when the investigative team laid

hands on a ribbon used in the Seikosha SPI000 printer. The printer for an Amstrad PCW is actually a Seikosha SPI000 with certain modifications to cut the price and to tie it in with the PCW.

Sure enough, Seikosha's own ribbon, the SP80051, clearly marked made in Japan is the same design as the original Amstrad ribbon (one lug) and is packed with the same amount of ribbon.

A call to Amstrad confirmed that the difference between the two ribbons was that one came from Japan with the printer and the other was made in Britain. A spokesman denied that there was any difference in the specification between the two although the Japanese ribbons "did give better value for money."

Amstrad say that they sourced the ribbons in this country because the price would have been prohibitive to ship them from Japan. True enough Seikosha are retailing their replacement ribbons at £7.50 compared with £5.95 for the Amstrad ribbon although that might still be regarded by some as a good investment.

There is competition coming from another source with the

West German company Pelican, who claim the title of the largest ribbon manufacturers in Europe. They are now offering a ribbon for PCWs. The ribbons may be marginally more difficult to obtain than the Amstrad ribbons, but at around £5.00+VAT for a 14 metres ribbon the company could make inroads into the market.

One thing that the great ribbon debate has raised is the seemingly endless number of tips for

prolonging the life of used ribbons, the most successful of which seems to be an application of WD40 oil (on the troubled waters of a ribbon war perhaps?)

To get hold of a Seikosha ribbon, you will need to find a Seikosha printer dealer. Pelican ribbons are well-known in the typewriter market, and any office equipment supplier should be able to order them for you.

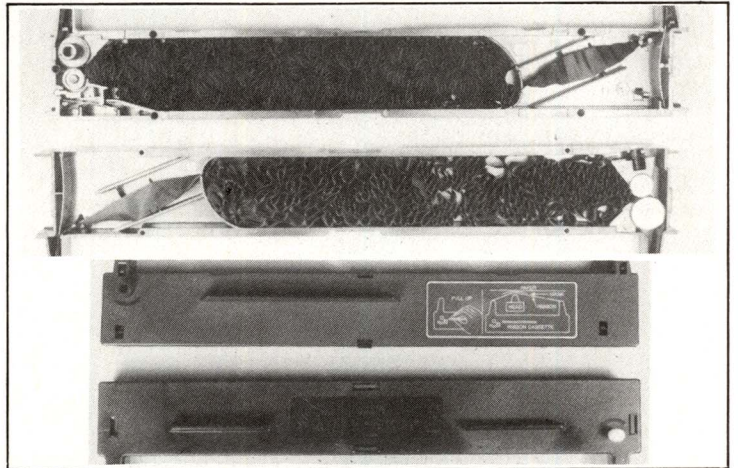

▲ The contrast between the original ribbon and the newer replacements. The lugs show the difference ...

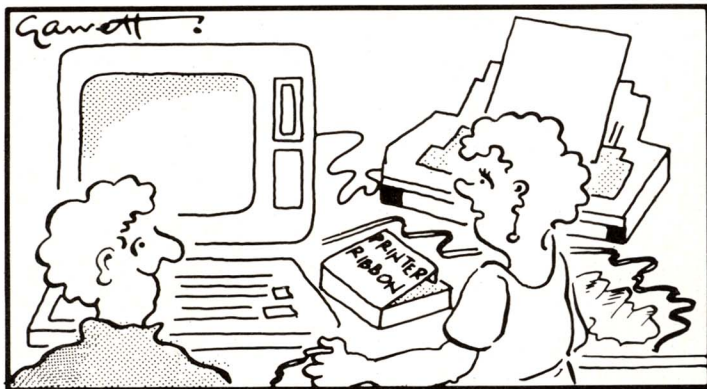

"EVEN THE RIBBON IT WAS TIED UP WITH IS LONGER..."

### CARBON COPY

Latest announcement from Amstrad is that they are offering a new carbon ribbon for the PCW, which should be available in the shops from the middle of March. The recommended retail price is the same as for the standard inked fabric ribbon (£5.95).

Carbon ribbons are widely used on electric typewriters. They are essentially a ribbon made of carbon paper, so that when the printer head hits it the carbon is transferred to the sheet of paper, giving a much crisper impression than inked ribbons.

The ribbon would seem a natural for PCW users looking for better definition on graphics from the PCW printer. Usually, you can only use carbon ribbons once, but those using the Amstrad ribbon hint that it is possible to get more than one run. It is also suggested that the carbon ribbon is less likely to be affected by a dry environment.

Amsoft's retail sales hotline is 0277 230222, who should be able to confirm availability and take orders.

### FASTER PRINTER

Amstrad have announced a new high quality printer, the DMP 4000.

Launched last month, the DMP 4000 is aimed primarily at the PC market, although it may well be worth a look from PCW owners who are dissatisfied with the speed of the standard printer.

At 200 cps (characters per second) in draft mode and 50 cps in near letter quality the new printer is twice as fast as

the standard one. It also has a 15" wide carriage (compared to the 10" standard printer) and comes in at the price of £349 + VAT. It will work on the PCW if you have a Centronics interface unit (the CPS 8256).

It prints up to 233 characters per line (in condensed) and has over 100 different typeface combinations.

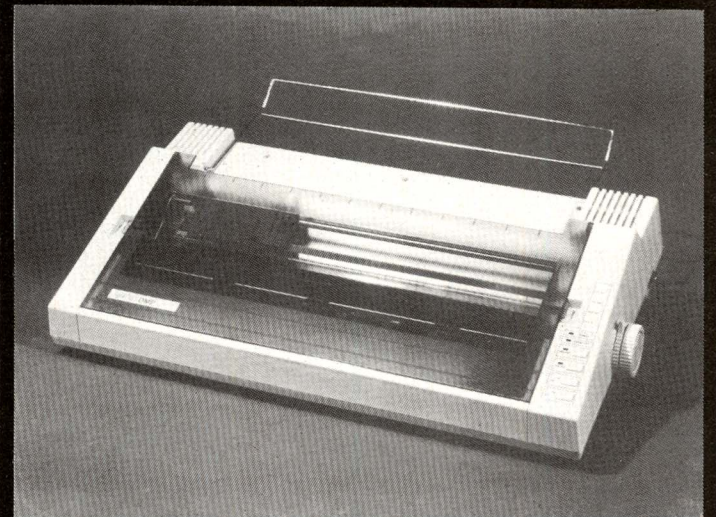



## STOP PRESS

Just as 8000 Plus was going to press we heard that the MACI printer housing unit and VDU stand offered in this month's competition on page 38 has just been renamed the "Neat 'n' Tidy".

The changes have come about since SBS Computer Supplies have taken over as sole distributors. The Neat (a printer housing unit that reduces noise) and the Tidy (the computer housing unit that raises the VDU to eye level and gives you a lockable area for disc storage) can be bought separately, although the company feel that they will still have strong sales from their special deal offer of £79.95 for both.

The prices are £44.95 for Neat and £39.95 for the Tidy, from SBS at 0273 726331 ... or you could win both in our fantastic competition in this issue.

## TRY IT AND SEE

If you are considering buying a modem and getting into electronic mail, you might like to know of a try-before-you-buy scheme.

British Monomarks are setting up a special free noticeboard to show how economical their Monodata systems is. Find a friend with a modem, set it to 300/300 baud, 7 bit, even parity, 1 stop bit. Dial 01-405 6020, and follow the simple on-screen prompts.

As Monomarks MD Stanley Solomons says, you can read a book review before you buy, so what better way to try out electronic mail?

## THE DATA ACT BITES



THE DATA PROTECTION REGISTRAR

The first signs of the Data Protection Act 1984 are beginning to show. The first 77,000 entries to be recorded on the Data Protection Register can be viewed on microfiche in 171 libraries throughout the country. This is a pilot scheme to allow members of the public to see the way in which entries are set out.

If you would like any advice on how the data protection act applies to you, you can get a pamphlet by ringing the Registrar's office on 0625 535777.

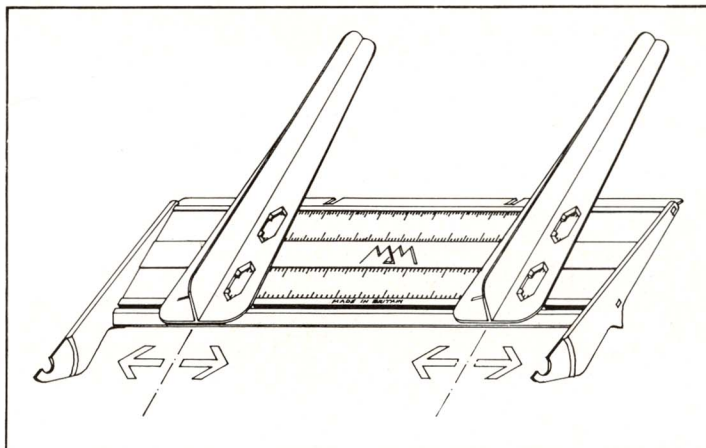

## LET'S GET THIS STRAIGHT

Architect C. Erik Andren has leapt to the defence of the maligned PCW printer stating that some of the sub-standard results are caused by your paper not being aligned correctly. His answer is Margin Maker MkII a device which allows you to quickly load and accurately align single sheet paper.

He suggests that time saved in setting up and paper saved will easily pay for the initial £14.95 outlay. The Margin Maker clips on to the standard PCW printer. It has 17, 15, 12 and 10 to the inch scales aligned to the screen ruler against which the two movable

(and lockable) paper guides can be indexed.

Set your chosen margin position and paper width, place the sheet between the arms and it seems the paper just slips down exactly straight to the take up rollers giving constant side margins and constant Header and Footer zone positions. It can be adjusted to suit different sheet widths or margin settings.

If you would like to get hold of Margin Maker, write to 121 Gresham Road, Staines, Middx TW18 2AJ.

## PUBLISHERS WANTED

The demise of Gemini Marketing Ltd of Devon has resulted in a plaintive cry from Nova Soft, makers of a video library rental management and control system.

The company now find themselves in the position of having what they consider to be a sound commercial software package and no publisher. Steve Potter of Nova wrote "I wonder if you could advertise the fact that we are looking for a company prepared to publish our package for the Amstrad 8512."

He points out that the package is ready and waiting for a publisher (the 70 page manual is even written, for goodness sake) and that the company would be interested in an outright or royalty agreement.

The program has more than 200k of code and controls the issue and return of films, daily takings report, various listing facilities, search for wildcard or specific up to 15 characters, reservations, label printer, letter printer with mail merge and many other features.

Always willing to help here are the details: write to Nova Soft, 39 Church Walk, Brinsley, Nottingham or phone 0773 768954.

On the same vein, General

Information Systems of Croxton, Cambridgeshire (0223 323143) are looking for help to develop their 'Red Box' equipment controllers for the PCW.

Red Boxes, already available on the BBC and Amstrad CPC machines, allow you to turn mains electrical equipment on and off by computer control - you could program your computer to act as a burglar alarm or turn your television on at the right time for Crossroads.

Despite reports in other magazines, Red Boxes are not available for the PCWs yet. General Information Systems didn't seem to think that there was any demand for Red Boxes on PCWs, and as such were not thinking very seriously about producing Red Boxes for the PCW. They did say however that they would do it if we lent them one of our machines for a fortnight!

Naturally we are so emotionally attached to our PCWs that we couldn't bear to be parted from them for that length of time but if there was anyone in Cambridgeshire who wasn't using their PCW for a couple of weeks and was keen not to miss Crossroads....?

## THE BOSS MAN COMETH

Will the ingenuity of games manufacturers never end? Alligata Software have just included a 'Quick the boss is coming' escape button for all those people who play computer games in the office when they should be slaving away over a hot word processors

The idea is that if you are in the middle of a game and suddenly hear the sound of ominous footsteps behind your back you use your lightning quick reactions to hit the delete key. Immediately the screen is filled with an impressive looking Word Processing Tutorial screen which the company suggest is certain to impress the head man, especially if he thinks he has caught you playing games.

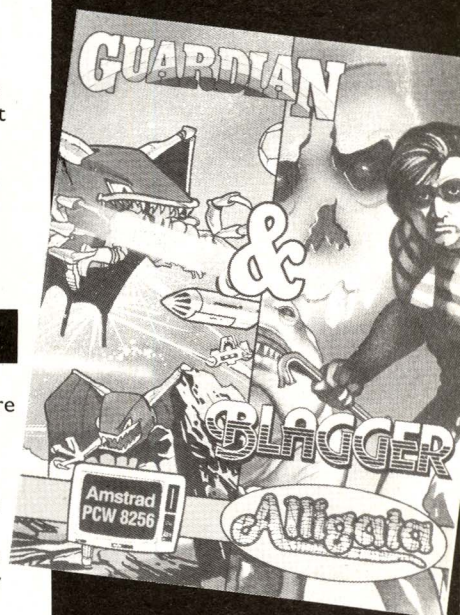

When he's gone you hit delete again and you are right back into the action with lives and points intact. This special feature comes with Bagger (a 20 screen platform game) and Guardian (a fast scrolling arcade classic) both on the same disc for £14.95.

However, be warned: this mightn't have the desired effect if you have all your workmates crowding round the screen shouting "Zap 'em" and "Watch that little rascal." Also be prepared to explain why you are still needing tutorial when you are supposed to be an expert at word processing. And finally remember it is possible that the boss reads 8000 Plus too.

Help to frustrate your boss from Alligata on 0742 755796.



## NEWS PLUS

### THE HEAT IS OFF

Remember all the scurrilous rumours about the Amstrad IBM PC overheating? ICI, where the trouble supposedly began, have now concluded that there are no overheating problems with the Amstrad PC 1512. Derek Seddon, ICI's director of Information Technology has written to Amstrad stating "The PC 1512 met all ICI's requirements for a 808X processor based personal computer and is judged to offer very good value for money.

"During the trials no problems were experienced with overheating when the Amstrad was connected to a token ring network." He confirmed that the machine had been approved for purchase by ICI operating units.

Mind you, near our deadline the keyboards of our humble PCW's seem to get pretty hot.

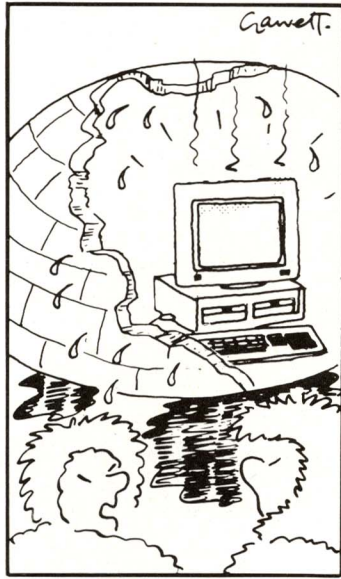

"I DON'T CARE WHAT ICI SAY:  
SWITCH THE DAMN THING OFF!"

### BUDGETING FOR SUPERTYPE UPGRADES

Users of Digita's 'SuperType' font utility program for the PCW will be interested to learn of some modifications.

Until now, SuperType only worked with LocoScript version 1.2, but Digita now have versions for LocoMail and LocoSpell too. At the same time, they have taken the opportunity to enhance the package.

The fonts have been redesigned so that proportional spacing works better, and for spaces to print out with a regular pitch. This means that tables and spreadsheets will now print with the columns reliably aligned.

Some characters have been changed too - the Olde English 'H', the quote marks and the underline character, which now gives a continuous line.

If you have bought SuperType in the last 60 days, you can upgrade free of charge by sending your disc back to Digita with a SAE. Other customers will need to pay £10 for

their year's software support subscription before they can upgrade. The support will also cover upgrades for SuperType when LocoScript 2 comes out.

Looking to the future, anyone who wants an easy way to organise their personal finances might want to wait for the introduction of Digita's new personal accounts and budgeting program, due out in the summer.

The company have just launched their Personal Tax Planner (see the review in this issue) which aims at taking the pain out of tax returns for those who have no wish to find out anything about tax regulations.

The aim of the new budgeting program will be to provide a package as easy and as fool-proof. The cost will be in the £25-£35 mark and is due out in June or July. If your finances are in a real mess perhaps you better start saving now.

Digita's phone number is 03954 5059.

### PUTTING THE AUTO-BOOT IN

Cornix Software Ltd have come up with the answer for users with CP/M-phobia - 'Universal Self-Start', a program to help you create self-start discs for all your CP/M software. With what is described as a 'simple installation procedure' you can produce self-starting discs that set the screen to full size or 24 x 80 mode, set the paper to single sheet or continuous stationery, set the printer to the pitch you want, set a suitable left margin and call up the main program.

The company freely admit that these functions can be performed using the supplied utilities but

point out that this is an easy-to-use alternative to "those who experience difficulty with, or are disinclined to use" the CP/M utilities.

Cornix claim simplicity of use with a "step-by-step instruction manual that assumes no prior computing knowledge." Mind you if you have some prior computing knowledge you might care to invest some time in reading the CP/M manual instead.

But if you've struggled and failed with SUBMIT.COM, PAPER.COM and PROFILE.SUB, try out Cornix on 0462 682989.

### FOLLOW THE CRITICAL PATH

A program to introduce PCW users into the world of critical path analysis has been launched by Pioneer Projects Ltd. The company claim that the program Simplan brings critical path facilities costing hundreds of pounds to PCW users for only £49.95. An enhanced version, Simplan Plus, is available for £69.95.

The company have aimed at a comprehensive but easy to use package that could be used by a newcomer to critical path planning. It uses form-filling and on-screen prompts to ease you through the process.

Further info from Pioneer at St. Helens, Uttoxeter Road, Abbots Bromley, Staffs WS15 3EG.

### STEVE DAVIS IN HOLLYWOOD

Now is your chance to take on Steve Davis at Snooker, Billiards and Pool at any time of the day or night. If that sounds a bit too much like hard work, CDS Software's Steve Davis Snooker also allows for two player games (your friends are much more inclined to make a mistake than Steve, even in computerised form).

CDS are confident of the display of the balls on the green screen (for those of you watching in black and white the pink ball is the one behind the blue) and enthuse about

the accurate spin control and infinite variety of power levels. There is also the ability to retake the last shot when you mess it all up (it seems the computerised Steve doesn't object). It comes with joystick controls.

Although Steve himself won't answer the phone, you can ring CDS at 0302 21134.

If snooker doesn't grab you, maybe showbiz appeals. Do you have a Hollywood mogul uncle Buddy Burbank, famous for his outrageous B movies? Well then you are just the right person to play Infocom's new adventure Hollywood Hijinx. Hijinx is a game for the PCW based round your attempts to meet some 'quirky' stipulations before you can claim your inheritance.

"This," claims the blurb, "is Hollywood at its glitziest." You must admit it sounds different. Hollywood Hijinx is being distributed by Activision, 01-431 1101. And if you don't have an uncle Buddy Burbank...well maybe you can play Steve Davis at snooker.

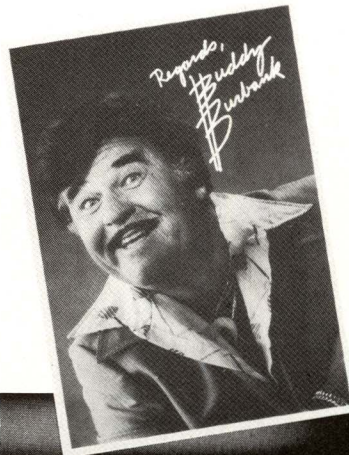



# Cracker2

The professionals' choice.

If you want a spreadsheet for the PCW8256/8512 that includes the more advanced features that other 8-bit CPM spreadsheets left behind when 16 bit PC developments become the vogue - then you have only one choice. **Cracker2**.

There is an unmatched range of *high resolution* graphics, which are created from embedded functions in the sheet itself, I/O control for the scientific user. Do-while loops for the goal seeking financial wizzard. Cracker2 has the lot, and more besides. Cracker is another NewStar product that bridges the gap between the PCW8256 and IBM PC, because although the limited features of other spreadsheets may be adequate for novice users, wouldn't you prefer to use a program that is upgradable to more micros than any other graphics spreadsheet ?

## Cracker2- £49 inc VAT

• Cracker2 offers the serious spreadsheet user the following important features in addition to the 'common' ones:

- ☆ User area management (essential for large capacity disk users)
  - ☆ Contextual help at every step of the way, just press '?'
- ☆ Sideways printout on the PC8256 or Epson compatible printers
  - ☆ Automatic date and calendar calculation facilities
- ☆ Control of input and output to & from a port address: read the temperature from your greenhouse and set the heating according to the season (in conjunction with the date functions!)
- ☆ Enhanced editions (Cracker3) available on the IBM PC to run under Concurrent CPM, DOS Plus or MSDOS
  - ☆ Multiuser support with shared file security
  - ☆ Facilities to embed printer control characters
- ☆ Sparse matrix storage techniques for maximum efficiency
  - ☆ Create and store standard standard templates
  - ☆ Macros to simplify repetitive keyboard tasks
- ☆ Automatic verification and check on the order of calculation to avoid the forward referencing problems that can afflict other spreadsheet systems, and thereby cause considerable inaccuracies
  - ☆ Comprehensive installation and customisation options
- ☆ Simple database facilities for mailing label and list printout
- ☆ DIF, comma delimited and ASCII data import/export built-in



Software Limited  
200 North Service Road  
Brentwood, Essex  
CM14 4SG

sales: tel 0277-220573  
tlx 995194 NEWSTA G  
fax 0277 232637

### ABOUT THE PC EDITION

For only £69, you get in addition: colour graphics (16 colour on the Amstrad PC), the powerful option of memory residency, mouse control, high speed scrolling, quick graph option, and now also a GEM™ edition. All data is interchangeable.



# SPREADING THE LOAD

A personal organiser, simple accounts package and cost estimator rolled into one? See the light, and discover the power of spreadsheets.

When you first bought your PCW, most likely your prime objective was to do word processing. Maybe after a couple of months, when you had mastered the ins and outs of LocoScript, you decided to splash out on a database to organise your record collection with. But where do you go from there? How else can your computer bring order to the chaos of your life?

ultimately only business acumen will solve. To plan your path to riches, you take out a notepad and write out:

Number of mousetraps: 10,000  
 Purchase cost: £5,000  
 Marketing cost: £1,000  
 Unit price: £1.95  
 Total profit:  $10,000 \times £1.95 - £5,000 - £1,000 = £13,500$

If you order a bigger production run, the cost per unit to you goes down and the profits go up, at the expense of a greater capital outlay. By deciding what investment you can afford, you can see what your return will be.

Here is where spreadsheets come in. The calculation just written down is what spreadsheets are really good at, only they can do it on a much larger scale. Spreadsheets are really computerised doodling pads ruled into columns and rows. On this pad, you can write down all the facts and figures relating to a problem, and then arrange them so you can see all the column totals, deficits, profits, averages and so on.

The strength of doing it by computer, rather than on paper, is that if you change your mind and want to see what would happen if you doubled the production run, the spreadsheet program will do it all for you. Just alter the essential facts, i.e. type in the details of the new order volume and cost, and all the figures that depend on them will be automatically updated for you. With great imagination, this is called a 'what if' feature.

It works because a spreadsheet is intelligent, in a computery kind of way. It doesn't just think of numbers as strings of digits, but it knows how they were worked out. In the mousetrap example, the spreadsheet knows (because you have told it!) that the profit is the number sold times the unit price minus the costs.

## What a spreadsheet really is

Spreadsheets are essentially financial planning and reporting tools. That sounds a bit dry, but properly used a spreadsheet can serve as a personal organiser, a cost estimator and a simple accounts package.

The cost estimator aspect has been covered to some extent in the mousetrap example. It is perhaps the home or simple business accounts part that appeals to many people going into business for the first time. Formal accounts packages are fine once you have got a system worked out, but inflexible if you are doing casual trade. For instance, accounts packages don't let you alter information once you've entered it, to preserve the integrity of the audit trail.

When you first load a spreadsheet program, you are faced with a screen which is totally blank apart from a number for each row and a letter for each column. Typically there will be 8 or so columns on the screen, each one about 10 characters wide, and 25 rows. Therefore you have a large number of 'cells', as they are called, and you can put virtually anything you like in each cell.

Imagine yourself setting out on a new business venture for the first time, with your design for a better mousetrap patented and ready to roll. The burning question is how much you should charge for your product to bring in the most money.

Charge too little, and you don't make enough profit to cover your overheads and costs. Charge too much, and no-one will buy from you. So where is the middle ground? This is an age-old problem, and one that

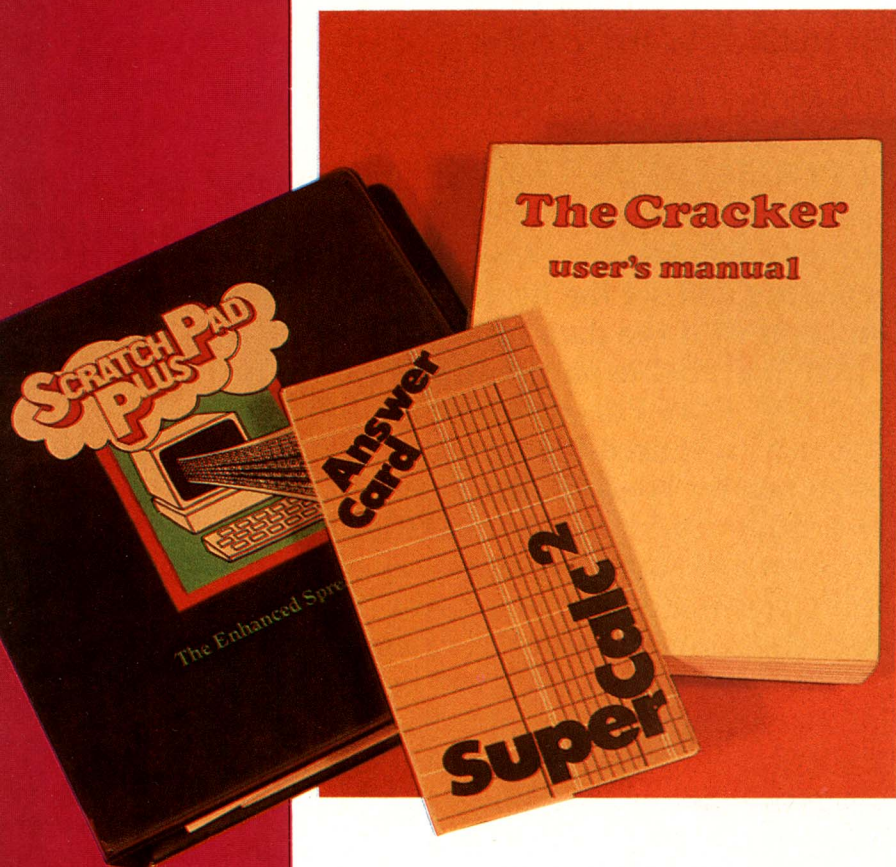



One thing to remember is that the cells that you can see on the screen are only a small section of the total available. The spreadsheet data can stretch over hundreds of columns and rows, with the screen being a 'window', showing a portion of the whole at any time.

How you organise the cells is entirely up to you, as best suits your application, but bear in mind that you can't print more than about 130 characters on a line on the standard PCW printer. This means that spreadsheets with lots of columns can be awkward to print out (but see the box on rotation programs).

For instance, consider the example shown of a typical multinational corporation's order book. Every cell is referred to by its co-ordinate - A1, B7 and so on. Using the cursor keys, you move to the cell which you want to fill, and type the text or number to go in there. You can type text onto the spreadsheet anywhere you like, to make it more readable, and then put numbers in the appropriate places.

If you type text, or a number like 43.12, that is what will be placed in the current cell. You can also enter a 'formula' which tells the spreadsheet to work things out for you. If you were positioned at cell A3, and you typed into the cell A1+A2, the spreadsheet would put into A3 the sum of cells A1 and A2. If A1 or A2 change later on, A3 will be automatically updated.

In the example, the 'Qty', '£ ex VAT' and 'VAT rate' columns have been typed in by the user, but the 'Total' column has been worked out by the program. So for row

Formula: B7\*C7/100\*(100+D7)      calc on E7  
Using Disk      Ready

Name	Qty	£ ex VAT	VAT rate	Total
Widgets	10.00	49.95	15.00	574.42
Manuals	10.00	9.95	0.00	99.50
Hot lunches	4.00	2.50	15.00	11.50
Sandwiches	5.00	0.95	0.00	4.75
Shotguns	25.00	80.00	15.00	2300.00
Clay ferrets	150.00	1.10	15.00	189.75
				3179.92

◀ To get this value, the formula B7\*C7\*(100+D7)/100 is entered

◀ To get the total, the formula SUM(E7:E12) is entered

▲ How a spreadsheet would deal with an order book

7, all you do is tell the program that the total is the quantity (cell B7) times the VAT-exclusive price, with VAT added on. A little maths shows that if VAT is x%, to get from the VAT-exclusive to the VAT-inclusive price, you just multiply by (100+x)/100.

At the bottom of the 'Total' column, the spreadsheet has been told to add up all the figures in the column, from cell E7 to E12 inclusive.

### Presentable results

Spreadsheets are useful planning aids, but you will want to be able to get a paper printout summarising the conclusions, either for your own benefit or to show colleagues.

Producing printed output is one area where spreadsheets are generally weak. The standard form of output is that you just print out everything you see on the screen, in the exact row/column format that it appears. You can choose to print out only a subsection, like the block A5 to E10 (meaning the block of cells with A5 at the top left and E10 at the bottom right), and you can omit the row numbers and column letters.

Of the specific spreadsheets mentioned in this article, only Cracker2 provides any degree of sophistication. With Cracker, you can analyse the spreadsheet data and produce graphs, bar charts or pie charts, and produce all manner of statistical analyses too. For more details, read the individual review.

### Cost estimating

Although spreadsheets are good general purpose cost estimators, you might be interested in two specialist programs marketed by Cornix. These are specially designed Job Coster and Product Estimator packages, costing £49.95 each. They do the functions of a spreadsheet in these areas, in a more friendly way.

### Double entendre

The word 'spreadsheet' is often used in two ways. It can mean the program itself, like SuperCalc2 or ScratchPad Plus, or it can mean the actual information which you have entered. It should be clear from the context which is which.

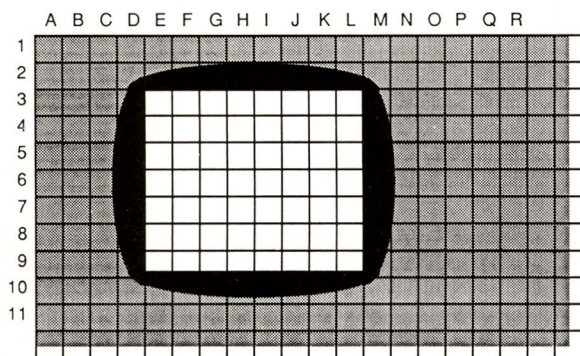

▲ How what you see on the screen relates to the whole spreadsheet

7, all you do is tell the program that the total is the quantity (cell B7) times the VAT-exclusive price, with VAT added on. A little maths shows that if VAT is x%, to get from the VAT-exclusive to the VAT-inclusive price, you just multiply by (100+x)/100.

At the bottom of the 'Total' column, the spreadsheet has been told to add up all the figures in the column, from cell E7 to E12 inclusive.

### Again and again and again

In the order book example, to work out the total for the first row you move to cell E7 and type in the formula B7\*C7\*(100+D7)/100 to get the right figure. Now if you alter the quantity of Widgets ordered in cell B7, the total for the row in E7 is automatically updated.

Essentially you want to repeat this calculation for rows 8 to 12, substituting the row number for 7 throughout. Do you have to retype the formula for every cell individually? The answer is that most spreadsheets have 'copy' command. Since spreadsheets are computer programs, 'copy' is far too short a word, so the process is called 'replicating' instead.

To generate the Totals column, you type in the formula for row 7 into cell E7 as explained. Now you give the command to copy cell E7 to cell E8, and the

## A child of its times

When you think of all the major software packages that people typically buy for computers, spreadsheets are the odd one out. Database, word processing and accounting programs have all been around since computers began, but spreadsheets are a relative baby.

The first ever spreadsheet was Visicalc, written for the Apple II microcomputer in the late '70s. Such was the success of Visicalc, it became

the main reason that people bought Apples.

Since then, spreadsheets have really taken off. The industry standard spreadsheet, which inevitably runs on an IBM PC or PC-clone, is called Lotus 1-2-3. A number of other software companies have written cut-price lookalikes of 1-2-3, at a fraction of the price, who Lotus are now in the process of suing (even though 1-2-3 was itself inspired by Visicalc).



# THE CHOICES

## SUPERCALC 2

£49.95 • Amsoft/Sorcim • 0277 230222

SuperCalc2 is possibly the most widely used spreadsheet for PCWs. It has been adopted by Amsoft as their recommended product, and is a good straightforward spreadsheet. The general descriptions on the preceding pages of what 'most spreadsheets' will do invariably apply.

The documentation that comes with it is large and comprehensive, and includes a '10 minute guide' to get you going, and a pull-out reference card. Surprisingly for an Amstrad product the manual is well indexed and comprehensible, but this is possibly because Amstrad didn't write it.

You can alter the column widths to suit your application – larger for text and smaller for numbers perhaps. If text is too long to fit in one cell, it just runs on over adjacent cells, so long titles don't need large column widths. You can also alter the format in which data is displayed to suit yourself; you can choose whether things are centred in columns, left or right justified, and how many decimal places to display.

Commands for SuperCalc to take some action are entered with a '/'. To save a file to disc, for instance, you type /S, and to load one /L. SuperCalc provides prompts on the screen to tell you what options are available at each stage, and what you are supposed to be typing.

The range of commands is quite wide. Two unusual ones are the ability to sort the spreadsheet data into order, and to execute command files. The command file function is particularly powerful. If there is a series of commands you find you are doing regularly, you can save the keystrokes in a file and run them automatically at the touch of a few keys.

Another useful feature is the IF command. Suppose you are compiling a list of debtors, and you want to charge anybody who owes you more than £100 a £10 aggravation fee. The IF command lets you test a cell's contents and work out a value depending on what the result is. So if the sum owed is held in cell B6, you can add a tanner to their bill by

`IF(B6<100,B6,B6+10)`

This just says, if the sum owed is less £100 then put the sum owed into the current cell, otherwise add £10 to it too.

## Printing from SuperCalc

One of the things that SuperCalc seems determined to make difficult is printing. The Amstrad printer can print in draft or high quality mode, and in sizes ranging from 17 to 10 characters per inch. Since spreadsheets can be quite wide, you will often want to use 17 pitch text.

It seems that Amsoft have sold different versions of SuperCalc over the years. Some always use 10 pitch text, and some always use 17 pitch text. The way to change it is to explicitly send control codes to the printer to alter the size.

The surest way to get the print size you want is to 'instal' SuperCalc specially. On side B of the program disc is the installation program, which is menu-driven. You need to alter the printer initialisation string.

The codes you will need to use are on pages 131-132 of the Amstrad CP/M manual. For example, to get high quality text, you need to send the

printer ESC m 1, as the manual says. ESC is ASCII code 1B, m is 6D, and 1 is the number 01. The ASCII codes are on pages 113 to 118 of the manual.

So, you need to send the 3 bytes 1B, 6D and 01. Therefore the SuperCalc printer initialisation string should be 3, 1B, 6D, 01. Now whenever you output to the printer using this installed version of SuperCalc, the program will instruct the printer to use high quality every time. You can set up condensed print in the same way once you have worked out from the manual the codes to send.

Depending on what version of SuperCalc you have, you may find that you can get high quality by simply using the [PTR] key and selecting 'High quality' before you start. Some SuperCalcs come pre-installed to reset the printer and override this, in which case you will have to resort to the method described above.

### PLUSES

- ☑ Can store repetitive keystrokes in command files
- ☑ Good manual, suits both beginners and experts
- ☑ On-screen prompts while you are working
- ☑ Good flexibility in formats, functions etc.

### MINUSES

- ☐ Spreadsheet size is limited by memory, not disc space
- ☐ No graphical output facilities

RANGE OF FEATURES ■■■■□  
EASE OF USE ■■■■□

PERFORMANCE ■■■■□  
DOCUMENTATION ■■■■□

8000 PLUS VALUE VERDICT ■■■■□

Name	Debt	Amount due
Al Capone	1.34	1.34
Mr. Dillinger	666.66	676.66
Mrs. Baker	34.17	34.17
Ronnie Kray	100.00	110.00
A.T. Hum	99.99	99.99
Genghis Khan	39.95	39.95

▲ SuperCalc listing out your bad debts for you

This cell is worked out with the formula `IF(B6<100,B6,B6+10)`

When you run SuperCalc, you are faced with a preset spreadsheet ruled in columns 9 characters wide. To enter numbers or formulae into a cell, just type them in (numbers begin with digits and formulae with letters). To enter literal text, like column headings, type a " and then the text.

## CRACKER2

£49.00 • NewStar Software • 0277 220573

When talking about the Cracker it is perhaps easier to say what it doesn't do rather than what it does. It doesn't go and make a coffee while you are trying to plough your way through the manual. Apart from that it is difficult to

think of many areas where it is weak.

It does the things that spreadsheets are supposed to do with a few extras in very sophisticated mathematical functions such as statistical analysis. But it can also be used as a database, which will sort your data numerically or alphabetically and will even print names and addresses on labels for you.

When you go to the bank manager to get your loan,



8000 PLUS	A competitor	Another Mag	Someone Else
97	36	35	34
92	34	33	34
95	38	35	34
51			

not only can you show him your neatly printed cash flow projections but you can show your profits over the last five years beautifully printed in one of six different graphs. Choose the best one to hide the fact that your profits have dropped steadily over that period and you are sure to impress.

The price that you pay for this variety of features and seemingly endless flexibility is that Cracker is not the easiest program to get to grips with. The manual is daunting and at 264 pages is indigestible.

You actually do get used to Cracker's commands very quickly and it has an invaluable 'Help' facility to steer you through the most difficult parts. But remember that unlike other spreadsheets, with Cracker you make up your own spreadsheet from scratch.

This means you choose the number of columns, the width, the depth, whether columns should take text or numbers and many other vital decisions so that you can get a spreadsheet exactly as you want it. So you need to have a fair idea of what you are trying to do before you can set it up, although you can add columns, add to the depth and change the designation of the cells later on.

On the other hand the beginner shouldn't be put off by the more exotic features. Once you have come to grips with the idea of setting up your spreadsheets you can build a library of your favourite matrices (yes - that is the plural of matrix) and to cover all your needs.

One handy feature is a number of sample spreadsheets and graphs. Even if you can't grasp the meaning of the manual it is often clear enough when you see the operation in action. Why not try the sample graphs in all the various styles?

For sophisticated analyses of your spreadsheet data, and neat graphical report, Cracker is a cracker.

A column of figures, and one of the many alternative ways Cracker can display them.

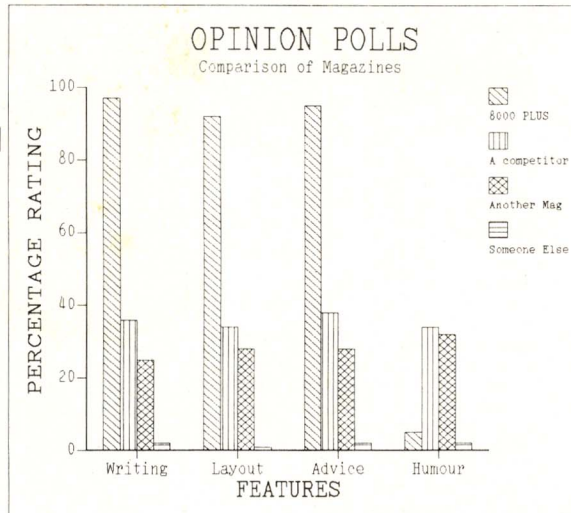

**PLUSES**

- The most sophisticated and flexible
- Can produce analyses and graphs
- Good help facility
- Once grasped the commands are easy to remember

**MINUSES**

- Off-putting documentation.
- Needs a fair grasp of what you want from a spreadsheet.
- Could be daunting for a beginner

RANGE OF FEATURES   
EASE OF USE

PERFORMANCE   
DOCUMENTATION

**8000 PLUS VALUE VERDICT**

**SCRATCHPAD PLUS**

**£59.99 • Caxton Software • 01-379 6502**

ScratchPad Plus is another good spreadsheet to be considered, which has some advantages and some disadvantages compared to SuperCalc (why do all manufacturers feel the compulsion to put capital letters in the middle of their product names?)

ScratchPad's main virtue is its 'virtual memory'. This is computerspeak for saying that it can handle very large amounts of data. The spreadsheet size is limited not by how much memory is free on your PCW (as per SuperCalc), but by how much space is free on your work disc.

The manual is good, but has no index which makes it hard to find what you want. Like SuperCalc, you can sort your data and alter the formats used to display numbers and text.

ScratchPad has a 'windowing' facility which is slightly superior to Supercalc's. If you want to keep your column headings on row 1 in view while you scroll down to row 347, you can split the screen into two windows. The top window can show row 1, containing the titles, while the bottom window shows the cells around row 347 for you. SuperCalc can do this too, but in ScratchPad you can have any number of windows compared to SuperCalc's limit of two.

There is no on-screen prompting, so you will need to have the manual to hand most of the time, and there is no equivalent of SuperCalc's command files for long, repeated sequences of commands.

Another annoying niggle is that although you can change column widths, all columns must be the same width. In SuperCalc and Cracker, any column can be any width.

Although the PCW printer can do 130 characters per line in compressed text, most spreadsheets allow you to put data in hundreds of columns, each one maybe 10 or more characters wide.

It is easy, on an application of any complexity, to build up more columns on the spreadsheet than you can print out on the printer. Your options therefore are to print the spreadsheet out in sections and paste them together by hand, or to use a rotation program.

Rotation programs take a file on your disc, turn its contents through 90 degrees and print it out. This is useful if you are printing a spreadsheet with, say, 50 columns but only 25 rows. The rows can all fit down the short side of

the paper, and the columns over the long side, or even over several sheets if you are using continuous stationery.

The only catch is that you need to convert your spreadsheet data into an ASCII file which the rotation program can then read. Most spreadsheets have special commands to do this: in SuperCalc, it is an option in the /O (output) command, and in the /P command for ScratchPad Plus.

Two suitable rotation programs on the market are Rotate, at £24.95 from Proteus Computing (01-748 2302) and Landscape at £19.95 from Systembuild (0778 344388). For the extra fiver with Rotate you get a choice of four different typefaces to use for the printing.

A good range of calculating functions is available, including trigonometry, averaging and IF commands. For really big spreadsheets, ScratchPad is the one.

**PLUSES**

- 'Virtual memory' means you can have very large spreadsheets
- Multiple windows mean you can see all the parts you want on the screen at once
- Good range of calculating functions

**MINUSES**

- Not much on-screen prompting
- All columns have to be the same width
- No graphical output facilities
- No index in the manual

RANGE OF FEATURES   
EASE OF USE

PERFORMANCE   
DOCUMENTATION

**8000 PLUS VALUE VERDICT**



# Advantage

The Independent Computer User Group

AUTHORISED PC-SIG DEALER

ORDERING — Prices include VAT and UK postage. Cash with order please, cheque, money order or bankers draft. VISA and ACCESS accepted by post or telephone. Send a stamped addressed envelope for our latest catalogue



PLEASE STATE WHICH COMPUTER YOU ARE USING



ADVANTAGE (EP6) 33 MALYNS CLOSE CHINNOR OXON OX9 4EW Tel: 0844 52075

## PCW & CPC SOFTWARE

EACH DISC: £8.95 (Advantage Members £6.95) Overseas add £1 per disc.  
The six discs below contain Public Domain software plus Advantage user notes.

**COMPLEAT UTILITIES** — Selective file copy erase, hide, rename and print, Sector editor, Z80 Assembler/Disassembler, Z80 Debugger, Erased File Find and Recovery (CP/M 2.2), Sorted Directory, File Scanner, Splitter, String Finder, Bad Sector Eliminator, Typewriter Emulator

**GAMES COMPENDIUM** — Chess, Colossal Cave Adventure, Othello, Mastermind, Awari, Life, Golf, Polish Pong, Maze, Biorhythms, Word Search Puzzle Maker, Calendar Generator, Noughts & Crosses, Banner Printers

**APPLICATIONS** — Inventory/Database, Library Utilities, Word Count, Alphabetic Sort, Simple Spelling Checker, Easy to edit Starter Dictionary, Disc Catalogger, File Squeeze/Unsqueeze (saves up to 40% disc space), Password Protection

**COMMUNICATIONS** — Modem7, SModem, Kermit (CP/M+), BINARY-HEX Converter and others

**AMUSEMENTS & DIVERSIONS** — 25 games & 8 utilities written in unprotected MALLARD BASIC, including Star Trek, Merchant, Hangman, Nim, Baseball, American Football, Calculator, Home budget and Label Printer

**SMALL C COMPILER** — produces machine code programs and includes 25k of documentation

## PC SOFTWARE

EACH DISC: £9.95 (Advantage Members £7.95) Overseas please add £1 per disc

We have an extensive library of over 600 PC-SIG public domain and user-supported discs. Here are some of the favourites:

**PC-WRITE**—Multi-function Word Processor with 100 page on-disc manual

**PC-FILE III**—Fully definable Database with 100 page on-disc manual

**PC-CALC**—Spreadsheet similar to 123 with 30 page on-disc manual

**PC-TUTOR**—Course in computers and DOS

**CASH-TRAC**—Household budget organiser

**PRO-COMM**—Communications package

**PC DESKTEAM**—More features than Desk Mate

**ULTRA UTILITIES**—Powerful Disc Doctor with disc mapper, unerase, sector editor

**BEST UTILITIES** Selective delete and copy, print spooler, Browse, super TYPE

**BEST GAMES**—Invaders, Pacman, Life, Bugs, castle (Adventure)

**ASSORTED GAMES**—Pinball, Catch The Baby, Frogger, Multi-Maze, War Game

**ARCADE GAMES**—3-Demon, Donkey Kong, Golf, Fortune, Breakout, Pango, Pitfall, Pyramid

**PC-CHESS**—Full feature, on-screen board

**OTHELLO**—Reversi game with graphics

**COLOSSAL CAVE ADVENTURE**—Extensive game

**STAR TREK**—Large graphics version

**TRIVIA QUIZ**—A two disc set £15.95

**CAVE QUEST**—Dungeons & Dragons game

**HANGMAN**—Well presented graphics version

**FUNNELS & BUCKETS**—A fun learning maths game for over 7's

## MIX C COMPILER

- Full Kernighan-Ritchie implementation
  - Fast linker to build an executable program from separately compiled files
  - Supports all data types, floats, bit fields, doubles, structures & unions
  - Unix C compatible
  - Extensive library of 175 functions
  - Optimisation tools for speed & space
  - 450 page manual describing compiler operation, C programming and tutorial
  - UK technical support from Advantage
- "Outstanding value for money" — CWA 2/87. Available for CP/M+ and MSDOS. Second drive or RAM disc is recommended for CPC owners.  
£38.95 Overseas please add £5

## NEW MIX C TRACE

A powerful aid to fast program debugging with four-window monitoring and animated trace which highlights each statement as it executes. Single step & continuous functions with dynamic monitoring of source, output, variables, symbols and memory. Unlimited breakpoints. Comprehensive manual.  
£38.95 Overseas please add £5

**MIX SCREEN EDITOR** £29.95 Overseas add £3. **MIX ASSEMBLER UTILITY** £10.95 Overseas add £1

\* BUY ANY 2 MIX PACKAGES — DEDUCT 10% ANY 3 — DEDUCT 15% ALL 4 — DEDUCT 20% Advantage Members may deduct £2 per item

## BORLAND TURBO PASCAL

The fastest Pascal compiler with programming environment, editor, error detection, window procedures, sound, colour and graphics.  
"Runs like magic" — PC Magazine  
Amstrad CP/M Version: £65.95 Overseas add £3 PC MSDOS Version £78.95 (Members deduct £2)

## NEVADA & UTAH COBOL

Features runtime error messages, random access and sequential files and integration of assembly language using DR MAC.  
£38.95 (Members £36.95) Overseas add £3

## NEVADA & UTAH FORTRAN

Random I/O file, assembly language support, function library + real time error reports.  
"Outstanding Value" — CWA 11/86  
£38.95 (Members £36.95) Overseas add £3

## FULL SCREEN TEXT EDITOR

Suitable for generating compiler source code — CP/M and MSDOS versions available.  
£10.95 (Members £8.95) Overseas add £1

## INDEPENDENT USER GROUP

Choose either Group-8 (CPC & PCW) or Group-16 (PC1512) for monthly newsletter, user support and software discounts.

Annual membership: £10.95 (UK) £13.95 (Europe) £16.95 (Rest of World)

"Quite the best and most flexible personal accounts system I've seen — doubles as an inexpensive business system" Computing with the Amstrad September 1985  
"Money Manager is good enough to make most programs of this type give up in shame" Popular Computing Weekly 17-23 April 1986

Unbeatable value

CPC464

# MONEY MANAGER

Unrivalled features

CPC664

SAVE £5 on RRP of £29.95 when you order direct from Connect Systems

PCW8256

CPC6128

ONLY £24.95 Incl. VAT, p&p

PCW8512

Financial management software for personal and/or small business use.

Money Manager is an easy-to-use system for recording all financial transactions, and for analysing them in a number of very powerful ways in order to facilitate sound financial management. It is ideal for controlling the finances of a small business, or for users wishing to control their personal finances in a business-like way. Use it to check bank statements, keep track of expenditure, monitor cash flow, make budgeting forecasts, prepare business financial statements, pacify your bank manager, convince the tax and VAT inspectors, avoid nasty surprises, etc. etc.!

12 months of entries are kept in a file stored on your disc. At any time, you may load a file into the computer memory, add to or edit the entries, analyse them, print statements, and then save the updated file for later use. Entries may be historic (for record keeping) or forecast (for budgeting). You may have any number of separate files, and make copies of files for archive purposes. You may advance the period covered by a file month by month.

Up to 100 separate transactions may be entered per month. Each entry consists of:

- The day of the month, e.g. 23rd of June.
- An account number, one of up to 9 defined by you to suit your circumstances e.g. 1=Barclays, 2=Visa, 3=Halifax etc.
- Reference, e.g. ABC123 for a cheque number or invoice reference.
- A class code, one of up to 50 defined by you to suit your circumstances e.g. h0=Household expenses, h1=Mortgage, h2=Rates or p0=Production, p1=Raw materials, p2=Assembly, p3=Packing, etc.
- A description so that you can see what each transaction was for, e.g. "New gearbox" or "Box of 10 discs".
- An optional single character mark which you may include for further classification, e.g. b=business, p=private, etc.
- The amount of the transaction, which may be plus or minus.
- A marker to indicate whether the entry is exempt, zero rated or taxable for VAT, or alternatively the actual VAT paid.

You may select categories according to account, class and mark (e.g. all entries, or all motoring expenses for business using a credit card, etc.) and produce reports on the screen or printer as follows:

- Full detailed statements, showing each transaction for any month or for the whole year.
- Detailed monthly VAT statement showing input and output amounts excluding VAT, the actual VAT and the total amount, plus totals and net VAT due.
- Tables showing the totals in each class for each month of the year.
- Tables showing the totals in each class for each account.
- Tables showing monthly maximum, minimum, average balances, turnover, cashflow etc.
- Bar graphs of any category month by month.
- Pie charts of annual totals for various categories (CPC version only).

Plus: standing orders — entries optionally sorted into date order — item search facility. Comprehensive manual and full set of practice data included.  
Full telephone support.

Send cheque or credit card number or phone for immediate despatch.



## Connect Systems

3 Flanchford Road, London W12 9ND 01-743 9792 8am-10pm 7 days a week





# DON'T PANIC!

## Out of Limbo

What do you do? No power on earth seems to know how to stop the machine once it has decided to commit this particular version to disc. Just mutter the words "Don't panic" as you press the f8=Options key. You enter a world of mystery with headings such as 'Limbo' and 'Hidden'.

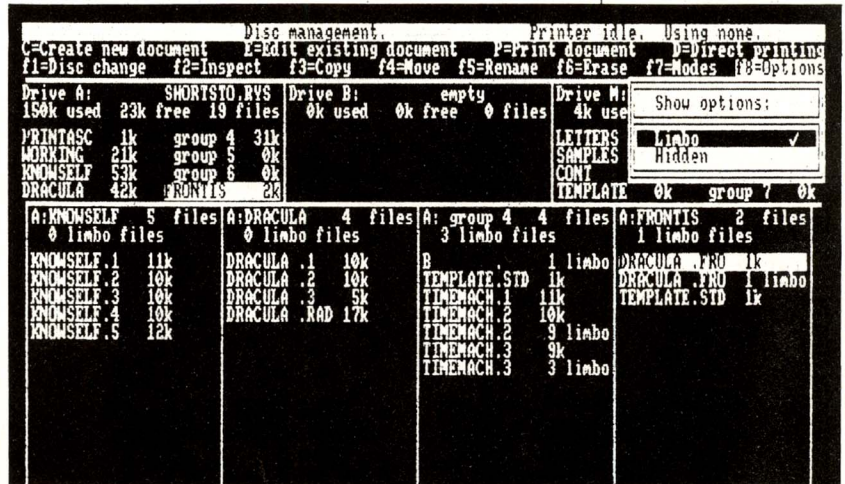

Alec Rae explains what to do in the unlikely event that something goes wrong when using LocoScript.

It might seem ridiculous to be writing an article about what could go wrong when using LocoScript. Everyone knows that LocoScript is so clear and simple it could easily be understood fully by a four year old child. So what could go wrong?

What happens if something does go wrong and there is no four year old child around to help you. You'd better read on – just in case.

Picture the scene. The wind is howling, a storm is raging outside and you decide you should really get on with your novel, now at page 1004 with only another 2000 to go. You look at the date – Friday the 13th. But this is the age of technology, you are someone who understands the intricacies of a computer. Why should you be worried by old-fashioned, outdated superstitions?

You load up LocoScript and put in your disc. Up comes the old familiar screen with all your documents listed neatly. Of course you have split up your chapters into neat five page sections for easy access.

You have already nearly finished the current section – a full four and a half pages. As you take a leisurely scroll down to the end (roll on LocoScript 2 with its jump to page feature) you notice that you have left out the most important part of your story development. No problem.

Three pages of brilliant prose later your current section now runs to eight pages instead of five. Again no problem. You read the article in last month's 8000 Plus and you know all about moving blocks.

In an instant you have marked out the text to move using [COPY] and [DOC] and at last you press [CUT] followed by your favourite block number. At that moment a mad dog howls at the moon outside your window and by mistake you press [EXIT] and chose the Save and Print option. As your finger touches the [ENTER] button you realise you didn't save the block by the old [f8] option.

Hidden is simple. There are certain files, such as the LocoScript system files that LocoScript presumes you don't want to know about. If you do want to know about them press  when the cursor is over the Hidden option and have a look.

What you are really looking for just now is the Limbo option. The other time this is useful is when you erase a file by accident. First you will see the titles of everything that you have written on the disc come flooding back like ghosts from the past. Erased files show up as well as the last file that has been superseded by your newly edited file.

To recover this file you press the 'f5=Rename' key and you chose the 'Recover from Limbo' option. You will be asked to rename the document in Limbo. You type in SALVATI.ON or some other suitably grateful name and then press E for edit as normal.

Then go to the end and cut out the relevant section again and save it properly this time. Still, no harm done eh?

## Only the names are changed

At that moment you suddenly realise that instead of calling the baddy George as you have been doing since the beginning of the book you have called him Fred after the character in real life that he is based on. Rather than face an expensive libel action you decide to change the names to protect your own innocence.

No problem. You call up the relevant document and press the special [EXCH] button – it is [SHIFT]+[FIND], if that helps you find it.

[EXCH] (for *exchange*, suitably enough) asks both for the word to find and the word to replace it with. You then have the more difficult task of deciding which option you require. If you know you have made the same mistake every time pick 'Automatic Exchange to end of Doc'.

If you know the mistake is on a certain page or paragraph you can use the relevant choices. If you are not sure use Confirm each exchange and you can chose whether to change the word or not using  for change and  for not changing.

[FIND] is a useful function in itself. Instead of plodding

## Limbo dancers

While Limbo is extremely useful it is important to make sure that the disc is not too full. As the space on the disc fills up the files in Limbo gradually disappear.

What actually happens is that when you erase a file from a LocoScript disc all it actually does is stop listing the title of that file.

The file is only actually erased when the disc is nearly full and a new file comes along looking for an odd corner. LocoScript will then cram it into any odd corners left after scrapping any files already 'erased'.



Editing text. Printer idle. Using A: Page 1 Line 22 of 54

AT=Letters/READ ME -P112 -L51 LP6 f1=Show f2=Layout f3=Emphasis f4=Style f5=Lines f6=Pages f7=Modes f8=Blocks EXIT

Exchange

Find: cursor  
Exch: cursor

Confirm each exchange  
Automatic exchange to end of PARA  
 Automatic exchange to end of PAGE  
Automatic exchange to end of DOC

The Print menu print out either typing 'P') lets you

The two choices some pages'. If this is printed. (Note: automatically prints the whole document.)

If you want to print only a section of the document, move the menu cursor to 'Print some pages', then press [ENTER]. (You will see the tick move to this line of the menu as well.) A second menu then appears on the screen. This tells you the numbers of the first and last pages of the document and has a section in which you can enter the page numbers of the first and last pages of the section that you want to print.

Enter the number of the first page of the section (the page you want to print from) with the menu cursor on the 'From page' line and the number of the last page of the section (the page you want to print to) with the cursor on the 'To page' line. For example, if you want to print pages 2, 3 and 4 of a six page document, you must enter '2' on the 'From page' line and '4' on the 'To page' line.

Move the menu cursor to right line and then enter the number either by typing the number and pressing [ENTER] or by stepping up or down from the displayed

through pages looking for your last reference to Qabalism you merely press [FIND] and when asked for the word type in Qabalism and [ENTER]. When the cursor stops it should be at the correct word.

## Qabalism

A good Scrabble word this. It's a Jewish form of mysticism or magic, and doesn't have a 'u' after the 'q'.

## My disc runneth over

Now you move to the next section of your book. The start of this is easy because you have it in a block saved from the last section (loaded using the 'f7=Modes' and 'Insert Text' option as described last month) and immediately the Muse smiles over your shoulder and soon the pages are disappearing out the top of the screen.

The lightning flickers outside. You are not quite finished but you quickly press [EXIT] and chose Save and Continue. This commits what you have written to disc and brings you back to write some more. If you don't do

this and the electricity does go off everything not on disc will, of course, disappear.

You quickly finish the section and press [EXIT] and 'Finish Editing'. A job well done. Just then a little green box appears in the middle of the screen informing you that your disc is full and giving you the choice of throwing away your latest piece of brilliant prose or go into Disc Management.

You may wonder why this should happen. You may have already looked to see that you had enough space for your latest section before you started. What you are inclined to forget is that LocoScript does not delete any superseded files until the new file is fully saved.

On this occasion you 'Saved and Continue'd although it can happen for a number of reasons. Still there is no room for the new file to go on in full. No Panic. You take the Disc Management option and you are suddenly back at the screen you see when you first load LocoScript with the names of all your files on show.

The idea now is to erase all the files you don't need, to create the necessary amount of space. As everything on this disc is precious you start to get clever instead.

You pick your biggest file and move it over to the M drive using 'f4=Move'. This involves simply putting the cursor over the file you want to move (as requested) press [ENTER] and then move to to the M drive section ([SHIFT] and → until you're there) and press [ENTER] again.

Once you have moved enough files to make room to save the file you were working on, press [EXIT] and your troubles are over. Well nearly. You have to make sure that you move back the file you have in memory or it will be lost when you switch the machine off.

If there is just is not enough room to get all the files on that disc you still have the option of holding them in memory, changing to a new disc, pressing 'f1=Disc Change' and moving the files back on to the new disc with the 'f3=Copy' or 'f4=Move' choices. Of course you have a spare disc already formatted. If not the files will all be lost anyway when you load Diskit to format a new disc.

You sit back content that you have steered your way through this difficult night with no major mishaps when suddenly the thunder crashes right above your house and the room is plunged into darkness. In the inky blackness the thought begins to form in your mind "When the power suddenly goes off while a disc is in the drive there is always the danger that everything on the disc could be lost." But of course you regularly take back-up copies of your work as a matter of course. You do, don't you? **EXIT**

## Start again

You decide to commit your latest five pages to paper. After what has gone wrong so far you place your continuous paper tractor feeder with extra care. Why is that people with honours degrees in computer science can still make a mess of it when they try to feed continuous paper into their Amstrad? Could it be that the continuous paper manufacturers put more holes on one side of the paper than the other?

You run the paper back and forward a few times just to make sure the mechanism is running properly and then press P, choose Print All Pages and away you go. It is time for a coffee and you swan off to put the kettle on.

When you get back you find that the cat has sat on the continuous paper and the last three pages have been written on one line, which by now is getting rather difficult to read.

You press the [PTR] key and the Printer Control Screen appears. The other more beneficial result is that the printer will, rather grudgingly stop printing to let you decide what to do.

One option is to press 'f7=Reset' to give up entirely and go away in the huff. A more practical solution is to press 'f5=Document/Reprint'. This will tell you where LocoScript has got to in the printing (not entirely obvious from reading the black mess on the page) and allows you to reprint some or all of the pages that have been spoilt.

The choices are reasonably obvious. You are asked if you want to continue from This Page, from the Previous Page or From Beginning. It then tells you to put your paper in the printer (implying "get it right this time") and away you go.





# The 64 Software Centre

1 PRINCETON STREET, LONDON WC1R 4AL – TEL: 01-430 0954

## Amstrad Software (PCW8256/8512)

### ACCOUNTS

Sage	-	Popular Invoicing .....	60.00
		Popular Payroll .....	60.00
		Popular Accounts .....	90.00
		Super Combo (Accts, Invoicing, Payroll) .....	180.00
Camssoft	-	Invoicing .....	45.00
		Payroll .....	45.00
		Stock control .....	45.00
		Sales ledger .....	45.00
		Purchase ledger .....	45.00
		Integrated accounts .....	135.00
Sandpiper	-	Accounting System .....	120.00
Advance	-	Money Manager .....	29.00
Map	-	Stock control .....	49.00
		Payroll .....	49.00
		Integrated accounts .....	140.00

### DATABASES

Advance	-	Database Manager .....	29.00
Amsoft	-	Microfile/Microword .....	45.00
Camssoft	-	Database .....	45.00
Caxton	-	Cardbox .....	55.00
Database	-	Plan it .....	24.00
Sage	-	Retrieve .....	60.00
		Magic Filer .....	60.00
Sandpiper	-	File Manager .....	90.00
Micropro	-	Pocket infostar .....	69.00

### WORD PROCESSORS

Tasman	-	Tasword 8000 .....	24.00
		Tasprint .....	14.00
		Taspell .....	16.00
Micropro	-	Pocket wordstar de luxe .....	69.00
Arnor	-	Protext .....	79.00

### SPREADSHEETS

Micropro	-	Pocket calcstar .....	39.00
Amsoft	-	Supercalc 2 .....	49.00

### AIDS & UTILITIES

DR	-	Draw .....	45.00
		Graph .....	45.00
Caxton	-	Touch'n go typing tutor .....	24.00
Mirrorsoft	-	Graphics Operating System .....	99.00

### EDUCATIONAL

FSC	-	Magic Maths .....	12.00
		Maths Mania .....	12.00
		Better spelling .....	12.00

### GAMES

Leisure	-	Scrabble .....	19.00
Domark	-	Trivial Pursuits .....	19.00
CDS	-	Colossus Chess .....	15.00
FPS	-	Annals of Rome .....	24.00
Rainbird	-	Pawn .....	24.00
CPS	-	Bridge Player .....	19.00
Infocom	-	Hitchhikers Guide .....	24.00
		Trinity .....	34.00

All prices include VAT – Add 2.00 for P&P (UK and Europe). Add 20% for other countries.  
Software is not sold on a trial basis. Software sold by mail order in the UK may be returned within 7 days of receipt, provided that it is not damaged, marked or soiled and any seals are intact, in which event the purchaser may claim a refund.



Credit Cards (Visa/Access) telephone orders accepted  
Hours 10.00 am/6.00 pm (incl Saturdays)





# Even Better Word Processing

LOCOSPELL (Soft 07070)

LOCOMAIL (Soft 07069)

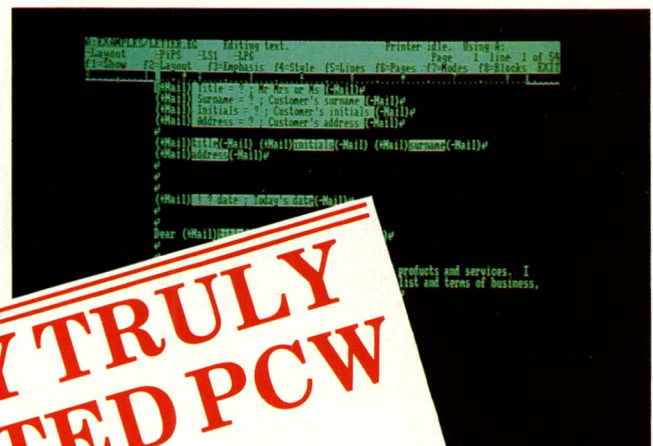
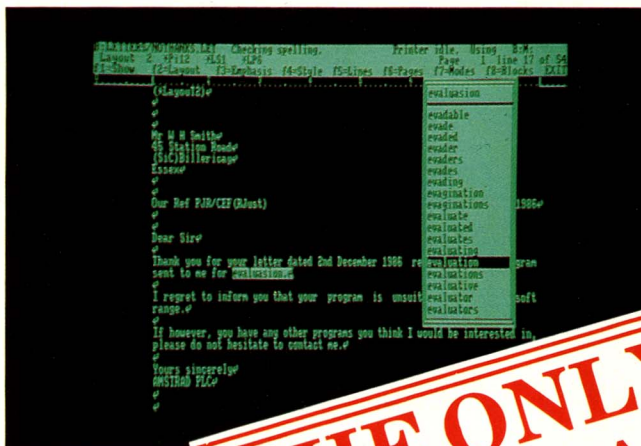

**THE ONLY TRULY  
INTEGRATED PCW  
SOFTWARE**

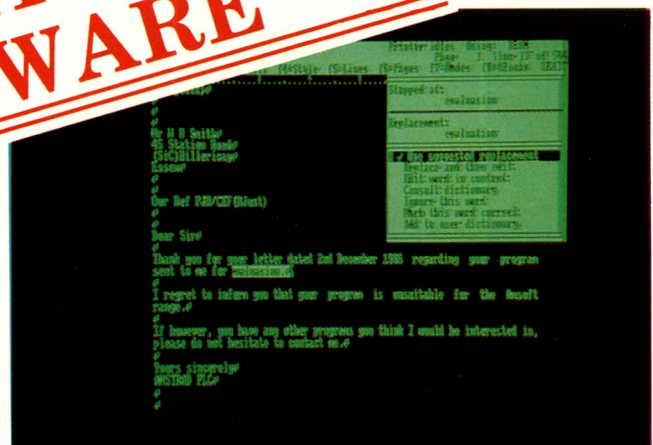
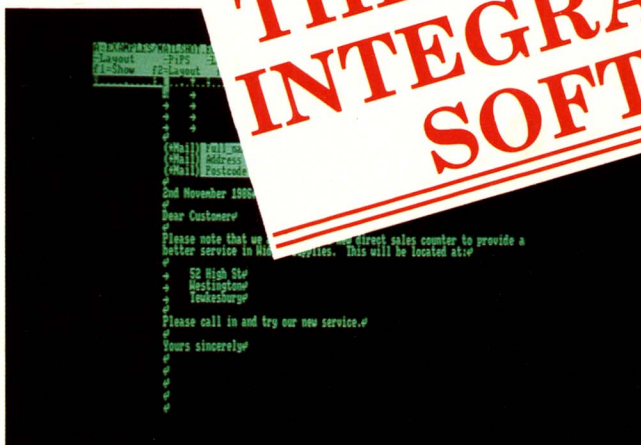

A powerful addition to your PCW enabling you to merge address lists and data with letters and forms to produce mailshots and personalised versions of standard letters. The many features of this software include, the ability to perform arithmetic functions.

The only official spellchecker to use with Locoscript. This software is supplied with a 32,000 word dictionary for use with the PCW8256 and a massive 77,000 word dictionary which operates with speed on the PCW8512. You can produce and edit your own dictionary which operates in conjunction with the main dictionary.

Software for the PCW8256/8512

PCW Practical Software

**Order your copies now  
at only £39.95 each**

Available from good Amstrad computer stockists.  
Or send coupon to Marketing Dept, Amstrad,  
Brentwood House, 169 King's Road,  
Brentwood. Essex. CM14 4EF.



Brentwood House, 169 King's Road, Brentwood  
Essex. CM14 4EF. Tel. 0277 230222

Send coupon to: Marketing Dept. Amstrad Consumer Electronics Plc, Brentwood House,  
169 Kings Road, Brentwood, Essex. CM14 4EF

Name .....

Address .....

Post code ..... Tel. No. ....

LOCOMAIL   
(Soft 07069)

LOCOSPELL   
(Soft 07070)

(PLEASE DO NOT SEND ANY MONEY WITH THIS COUPON)



# OF MICE AND MEN

## KEMPSTON MOUSE & WRITE HAND MAN £89.95 • Kempston Data • 0908 690018

Since the introduction of the Amstrad PC, a new illness has been discovered by psychiatrists. Certain PCW users are exhibiting symptoms of 'mouse envy' – or at least that would seem to be what we are being persuaded by peripheral manufacturers.

Until now there has been a singular lack of these little unfurry friends on the desks of PCW users. A "chicken and egg" situation developed where there was no need for the mouse because there wasn't the software and no one would develop the software because there were no mice.

Kempston are hoping to break this deadlock by producing their PCW mouse and inviting the software industry to take up the challenge.

### Your right hand mouse

Kempston see the major launch of their mouse being with Mirrorsoft's Fleet Street Editor Plus, the desktop publishing program.

In the meantime they are selling their package with a special version of Hisoft's Write Hand Man, a pop up desk accessory aimed, it would seem, at programmers. It would be unfair to judge the value and usefulness of the mouse on this particular package. Like a keyboard, a mouse is only as good as the software it controls.

Write Hand Man is a useful package in itself. It provides a number of facilities such as a pocket calculator and notepad which can be run while you are still working on another program. Whenever you press both buttons on the mouse together, a menu with 10 choices drops down on the screen. By moving the mouse, you can flick easily through the 10 options that the program provides.

This allows you to take notes, check phone numbers, list appointments in a diary, view a calendar with dates up to the year 2000, use a calculator, or view files and disc directories. When you have finished with Write Hand Man, you are returned to whatever program you were running before.

For the technically minded there are also programmable keys, allowing eight 'key macros' to be defined and stored which can then be used in any program. This means that you can define any key to produce any string of characters, for example a command that you regularly use. Now you can make the rarely-used function keys (f1 to f8) to do useful things in the programs you use.

There is a Hex calculator, an ASCII character table and an interesting swap feature that allows you to store a program in a special file, run another program and then return to the first one.

Wanting to use this package would usually mean that users are fairly computer literate and as such they could

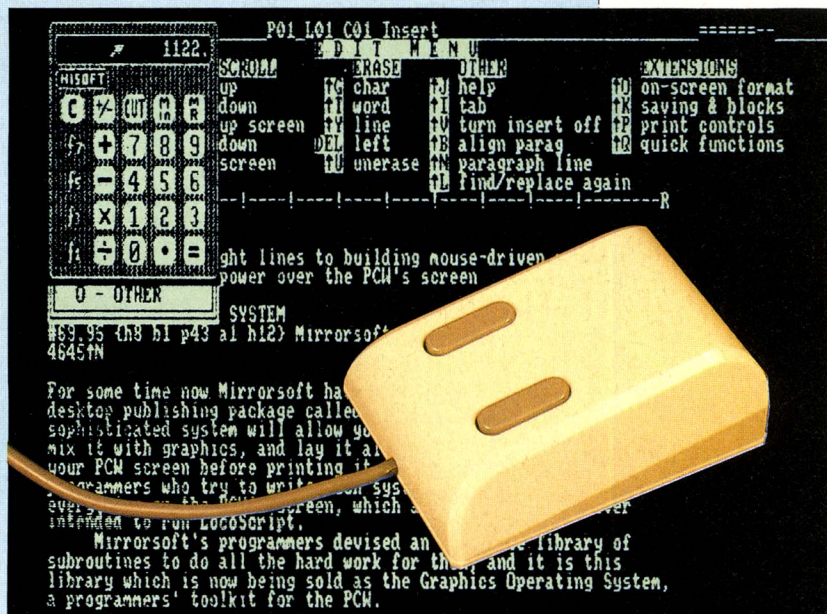

▲ The Write Hand Man calculator, with the mouse's arrow pointer showing.

probably devise their own cunning uses for the mouse in BASIC programs. You can even use it through an RSX in other CP/M programs. Probably the only really useful application of this would be in a spreadsheet where you could move about the screen with far greater ease.

The mouse works well for the limited application that is required of it. The interface fits into the expansion port at the back of your PCW easily enough although there is no through-connector to add on any more attachments as with Electric Studio mouse.

## Are you a WIMP?

The mouse is a relative newcomer to the computing scene. It was developed by Xerox in the USA to be used as an alternative to the keyboard.

The idea is that instead of typing commands in response to a prompt, as with CP/M, the computer shows you a menu of 'icons' (symbols). You then point with the mouse to the one you want to use and click a button on the mouse. This system is known as a WIMP – Window, Icon, Mouse and Pointer – system.

The advantages of a mouse over a keyboard have become apparent since

the success of the Apple Macintosh computer, and the GEM software system which is a Macintosh lookalike for IBM PC's. Desktop publishing programs in particular would be almost impossible to use with a keyboard alone. Using the mouse, you just point where you want things to go, drag them into place and stretch them to size by eye.

The Kempston Mouse and Mirrorsoft's Fleet Street Editor Plus will undoubtedly be a powerful partnership.

### Mouse or white elephant?

Frankly, Write Hand Man could be used more simply with the keyboard than the mouse. But this does not mean that anyone who buys a Kempston mouse just now will be left with a 'white elephant'. Kempston are now actively involved with a number of software companies to make sure that their mouse becomes a totally standard peripheral recognised by all suitable software.

In particular, the mouse could be used with desktop publishing programs, graphics programs such as Timatic's Microdraft or EG Computer Graphics new 'Draughtsman', and even games like Rainbird's Starglider. They are also looking for someone to write a package similar to the PC's GEM software.

Without the proper software no mouse can show its real worth. Now that Kempston have attacked the market they are determined that they will soon have applications to persuade users that a mouse will be a necessity rather than a frill.

EXIT



# THE SECRET LIFE OF SUPERCALC

Attention SuperCalc owners! Discover how your spreadsheet can sort out LocoScript files, and type in the first ever SuperCalc listing

**S**uperCalc2 is the biggest selling spreadsheet on the PCW machines. Although it is simple to get into, it is also capable of some powerful medicine when the need arises – too many people go through life using only its simplest functions.

How often have you had a list of names and addresses that you want to sort into alphabetical order? If you have a database, then fine, but otherwise SuperCalc can help. All you need to be able to do is produce and read ASCII files of the names in question, a task that even LocoScript can do.

How a set of names should look inside LocoScript

```

B:group0/LIST.LOC      Editing text.
-Layout      -File2    -LS1    -LP6
f1=Show      f2=Layout  f3=Emphasis f4=Style  f5=Lines
-----
"Fothering-Thomas, Col. G"e
"Bloggs, Fred"e
"Zapalowski, Len"e
"Sparks, Edmund Peter"e
"Bloggs, Albert"e
"Moir, Michael Q"e
"Aardvark, Aaron"e
    
```

SuperCalc that it is text rather than a command. Eventually, these names will be sorted into order by the first letter of each one, so put the surname first if you are sorting by surname.

For example, to enter Karl Marx's personal details, put the cursor in the next available cell of column A and type "Marx, Karl, Highgate Cemetery

Once you've got all your names in there, put the cursor anywhere in column A and type /A. This is the 'Arrange' command which does the sorting. Type C to sort by column, and press [RETURN] to indicate it is the current column. Abracadabra, it is suddenly in the right order.

To get the data out of SuperCalc, first turn off the row and column borders with the command /G,B then use the output command, /O. It goes through a long list of options with you: choose D for Display format, A for the range of cells to output, D for Disk file output, and finally pick a filename to hold the result.

You can now leave SuperCalc, although you'd better save the file as a normal file with the /S command in case you want to add to it later on, to save you retyping it all. The file you created with the /O command is a straightforward ASCII file of the data, sorted as it was on the screen.

You can start up your word processor, include this file in your document, and carry on processing it. In LocoScript, this means using the [F7] key and the 'Insert Text' option while editing the file you want to insert the names into.

<pre> 1:Fothering-Thomas, Col. G 2:Bloggs, Fred 3:Zapalowski, Len 4:Sparks, Edmund Peter 5:Bloggs, Albert 6:Moir, Michael Q 7:Aardvark, Aaron 8: 9:     </pre>	<pre> 1:Aardvark, Aaron 2:Bloggs, Albert 3:Bloggs, Fred 4:Fothering-Thomas, Col. G 5:Moir, Michael Q 6:Sparks, Edmund Peter 7:Zapalowski, Len 8: 9:     </pre>
--	--

▲ An unsorted column of SuperCalc, and the same after the Arrange command

## SuperCalc to LocoScript

Suppose you have your names and addresses on paper, and you are typing them into the computer for the first time. Start SuperCalc going, and alter the width of column A to be 80 characters (or at least as wide as the longest line you want to type). Use the /F command for this.

Now type in the names in any order you like into column A. Precede every entry by a double quote, to tell

## LocoScript to SuperCalc

To use SuperCalc to sort a list of names already held in a LocoScript document is a little trickier.

The first thing to do is to make sure that the names to be sorted are in a LocoScript document all of their own. Don't have any text you don't want to be sorted on that file. Arrange the names, or whatever the data are, one per line with a [RETURN] ending each one. Make sure none of your data has double quote marks in it – if it does, use the [EXCH] function to replace them with single quote marks instead.

Go through the whole file putting a double quote mark at the beginning and the end of each line. A cunning way to do this is to use the [EXCH] function again to replace all occurrences of [RETURN] by "[RETURN]", then manually adding one at the start of the first line and removing the extra one after the last line.

Finish editing the file, and make an ASCII file of it in group 0 of a CP/M disc. Start up CP/M.

## SDI – don't tell the Russians

On side 2 of your SuperCalc master disc is a program called SDI. Contrary to what President Reagan thinks, SDI stands not for 'Strategic Defense Initiative' but for 'SuperCalc Data Interchanger'. SDI is the program that does the job of converting ASCII files into a form that SuperCalc can understand.

From the copy of SDI on your working SuperCalc disc (you did copy it, didn't you?), run it by typing S D I. You

## Comma separated comment

SDI converts 'comma separated' files into SuperCalc format. What has this got to do with the palaver of putting double quotes around all the data in the LocoScript file?

Comma separated files are standard files as used by BASIC and other languages. What it means is that the data is held in lines, with commas separating each item. Text is enclosed in double quotes, but numbers are left plain.

SDI can convert a comma separated file into a full spreadsheet of many columns. For example, if you typed up

a line of text like

"One",2,3,"Four"

then ran this through SDI and loaded the result into SuperCalc, you would end up with a four-column spreadsheet with the words 'One' and 'Four' in columns 1 and 4, and the numbers 2 and 3 in columns 2 and 3.

When, in the example in the main body text, data was being transferred from LocoScript to SuperCalc, only one column of the spreadsheet was ever used, so there was only one item per line and no commas.



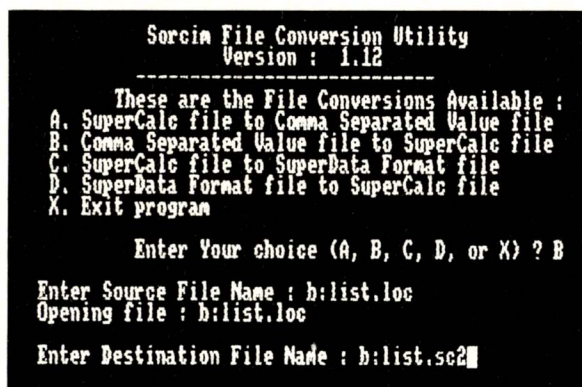

▲ The PCW screen as SDI runs

## A SUPERCALC TYPE-IN UTILITY!!!

This utility is a fairly simple personal finance checker, and has nothing at all to do with the previous section on sorting data and shifting it to and from ASCII files.

The listing has been produced directly from SuperCalc, using the /O command and the 'Contents' option. As you can see, every line of the listing starts with a SuperCalc cell number (eg. A2), then has a blank or some hieroglyphics and an equals sign, and finally has some text or a number.

To type in this listing, start SuperCalc running normally. Set the width of column B to be 20, but leave all other columns unchanged. For each line of the listing, use the cursor keys to get to the cell given in the line, and then type in exactly the text following the equals sign. If it starts with a single or double quote mark, make sure to type that correctly.

The '\$TR' between the cell number and the equal sign on some lines tells you the format that was used to display the entry. After you have typed in all the cell contents, go over the spreadsheet and alter the formats so that all the columns line up nicely. To do this, use the /F command to set the format of a cell to \$TR if appropriate, otherwise leave the format alone.

When you have got all the formats right, don't forget to save the spreadsheet to disc with the /S command. Call the file something like CASHPLAN.TEM – TEM for 'template'.

### Using the personal financier

Don't enter data directly into your CASHPLAN.TEM file you just created, since you will need to use a fresh spreadsheet each month. Instead, copy CASHPLAN.TEM to a new file, for the month you are going to work on – say CASHPLAN.APR for April and bring that file up into SuperCalc.

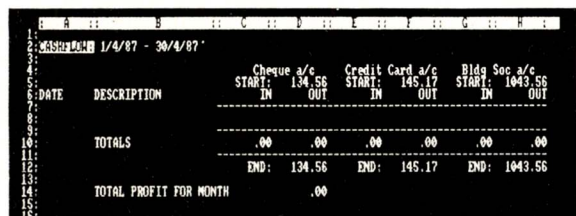

▲ The screen before you type any data in

You are now faced with the screen as shown. The program assumes that you spend money in three ways: a cheque account, a credit card and a building society account. There is an IN and OUT column for each account, with the balance in the account at the start of the month listed out. We've picked arbitrary figures, so replace them with your own (cells D5, F5 and H5).

now see a menu offering you various choices – the one you want is B, "Comma separated file to SuperCalc format". In case you are wondering, all the double quotes you put in the names list in LocoScript were to make the file a 'comma separated' file for SDI's benefit.

Put in the disc with the ASCII file you created, and type its name as SDI asks you. Think of a name for the resulting file – probably 'something.SC2' is a good choice.

After a short pause, SDI finishes. You can now run up SuperCalc and load (with /L) the .SC2 file you just created. Now go on as described in the first section – make sure column A is set wide enough, use the Arrange command to sort the data, output it to a disk file and finally read it back into LocoScript. After all this, you have now gone from an unsorted LocoScript file to a sorted one. What more could you want?

A2	= "CASHFLOW: 1/4/87 - 30/4/87	H6 \$TR	= "OUT
C4	= " Cheque a/c	C7	= '-
E4	= " Credit Card a/c	C9	= '-
G4	= " Bldg Soc a/c	B10	= "TOTALS
C5 \$TR	= "START:	C10 \$TR	= SUM(C8:C9)
D5 \$TR	= 134.56	D10 \$TR	= SUM(D8:D9)
E5 \$TR	= "START:	E10 \$TR	= SUM(E8:E9)
F5 \$TR	= 145.17	F10 \$TR	= SUM(F8:F9)
G5 \$TR	= "START:	G10 \$TR	= SUM(G8:G9)
H5 \$TR	= 1043.56	H10 \$TR	= SUM(H8:H9)
A6	= "DATE	C11	= '-
B6	= "DESCRIPTION	C12 \$TR	= "END:
C6 \$TR	= "IN	D12 \$TR	= D5+C10-D10
D6 \$TR	= "OUT	E12 \$TR	= "END:
E6 \$TR	= "IN	F12 \$TR	= F5+F10-E10
F6 \$TR	= "OUT	G12 \$TR	= "END:
G6 \$TR	= "IN	H12 \$TR	= H5+G10-H10
		B14	= "TOTAL PROFIT FOR MONTH
		D14 \$TR	= C10+G10-D10-H10

Whenever you cash a cheque, or make any other transaction on these three accounts, make an entry on the spreadsheet. To make an entry, place the cursor on the bottom row of dashes and insert a new row (with the /I command). The 'totals' section moves down and leaves room for your data.

Type in the date, a memory-jogger description and enter the sum in the appropriate column. For credit card purchases, the IN column records you paying off a bill, and the OUT column is for your purchases on the card.

And that's it. SuperCalc itself automatically keeps track of the figures from now on. You will see your balance, at the bottom of each column, changing. SuperCalc works out the totals of each column by adding up all the cells in it between the two horizontal dashed

DATE	DESCRIPTION	Cheque a/c		Credit Card a/c		Bldg Soc a/c	
		IN	OUT	IN	OUT	IN	OUT
1/4/87	pay		548.67				
2/4/87	cash		50.00				
5/4/87	petrol		100.00	100.00	10.00		
7/4/87	c.c. payoff		100.00	100.00			
7/4/87	road tax		50.00				
10/4/87	cash		25.00				
10/4/87	sub to 0000 Plus				17.95		
15/4/87	mortgage		185.46				
20/4/87	holiday money					250.00	
21/4/87	austral share div		64.30				
	TOTALS	612.97	420.46	100.00	27.95	00	250.00
	TOTAL PROFIT FOR MONTH		327.07		73.12		793.56
			-57.49				

▲ The results after a few days' use

lines. No matter how many rows you insert, you don't need to change the totalling formulae on row 10.

At the end of a month, or whatever accounting period you have chosen, make a note of your current balances, make a new copy of CASHPLAN.TEM for the new month's data, and transfer the totals by hand into the starting totals in your new sheet. EXIT

### Entering dates

SuperCalc has a special command to enter the current date into a cell. Just type TODAY into a cell – no quotes or slashes – and SuperCalc will pick up the information in the PCW's clock automatically. You will need to set the clock before you run SuperCalc with CP/M's DATE command.

### For all the rest

For those of you who do not have SuperCalc spreadsheets these facilities can also be found on many other spreadsheets of course. Cracker, for example, can sort out your data alphabetically or numerically and has a search facility so that you can use it as a proper database. You can then print out names and addresses on labels if required. Perhaps not what you would expect to use a spreadsheet for.



THE ORIGINAL

# EASY LABELLER

PURPOSE DESIGNED TO SOLVE ALL YOUR LABELLING NEEDS  
NO FILES - NO FUSS - VERY FAST - EASY TO USE



24 HOUR  
ACCESS  
ORDERING  
SERVICE

### PROGRAM FEATURES

- \* PRINTS SINGLE LABELS
- \* PRINTS MULTIPLE LABELS
- \* PRINTS LABELS BY CATEGORY
- \* 99 CATEGORIES
- \* DIFFERENT TYPE STYLES
- \* UP TO 2000 LABELS PER DISC
- \* ANY SIZE
- \* ANY NUMBER ACROSS THE WEB
- \* DATE STAMPING
- \* CONSECUTIVE NUMBERING
- \* LABEL CODING
- \* FULL ON SCREEN EDITING
- \* COMMAND DRIVEN
- \* FIND AND CHANGE TEXT
- \* FIND AND PRINT TEXT
- \* INSTANT ACCESS
- \* ON SCREEN HELP
- \* NEW DISC GENERATION
- \* SET MARGINS & GAPS
- \* INSTANT AUTOMATIC SORT
- \* PAUSE PRINTING BETWEEN LABELS
- \* LIST BY CATEGORY STARTING FROM ANY LABEL
- \* SCAN LABELS FOR EASY UPDATE
- \* PLAIN PAPER LISTINGS OF ANY LABEL DETAILS IN ANY ORDER STARTING FROM ANY LABEL
- \* NON PRINT INFORMATION E.G. TELEPHONE NUMBERS ALLOWED ON LABELS
- \* MULTIPLE DATA DISC
- \* GIVING UNLIMITED LABELS AND SIZE
- \* TEST PRINTS
- \* TEST PATTERNS
- \* LISTS ALL NAMES & CATS.
- \* USE WITHIN 2 MINUTES
- \* + OTHERS

### FOR USE BY

- \* SHOPS
- \* CLUBS
- \* MAIL ORDER COMPANIES
- \* MANUFACTURERS
- \* WHOLESALEERS
- \* PACKERS
- \* DISTRIBUTORS
- \* RETAILERS
- \* SCHOOLS
- \* CARRIERS

### ADDRESS LABELS

89 x 36M	2000	4000	8000
Nett	9.00	17.00	32.00
Vat	1.35	2.35	4.80
Total	10.35	19.35	36.80

OTHER SIZES AVAILABLE

JUST

**£29.95** + £4.49 VAT

POST & PACKING FOR  
TRADE, DISTRIBUTOR  
& EXPORT ENQUIRIES WELCOME

PC1512 VERSION  
NOW AVAILABLE

### USES FOR

- \* ENVELOPES
- \* PARCELS
- \* BOTTLES
- \* FOOD
- \* ADDRESSES
- \* MAILSHOTS
- \* MANY OTHERS

### COMPLIMENTARY

500 FREE LABELS WITH ALL ORDERS  
SEND YOUR ORDER TODAY TO:

M.A.S.S. FREEPOST (8000APR)  
43 WYMER ST.  
NORWICH  
NR2 4BR  
TEL: (0603) 630768  
No stamp required.

PLEASE STATE  
COMPUTER TYPE

PLEASE NOTE: EASY LABELLER IS A PURPOSE DESIGNED PROGRAM AND NOT A DATA BASE ADAPTION. THE NEED TO DEAL WITH CP/M DISC FILES IS NOT REQUIRED. HUNDREDS OF SATISFIED CUSTOMERS, BOTH EXPERIENCED AND FIRST TIME USERS, HAVE FOUND EASY LABELLER INVALUABLE FOR PRODUCING MAILING LABELS, TICKETS, CONTINUOUS ENVELOPES ADDRESSING AS WELL AS A QUICK AND EASY TO USE FILING SYSTEM.

## Short of Floppy Disc storage ?

### 3" Discs now available

New low price for these top  
quality discs. Suitable for  
all Amstrad disc based  
computers.

*Except the PC1512.*

Order your CF-2 Discs now

**ONLY £2.99 each**

Available from good Amstrad computer stockists. Or send coupon to  
Marketing Dept, Amstrad, Brentwood House, 169 King's Road,  
Brentwood, Essex. CM14 4EF.

# AMSTRAD

Brentwood House, 169 King's Road, Brentwood Essex. CM14 4EF.  
Tel. 0277 230222

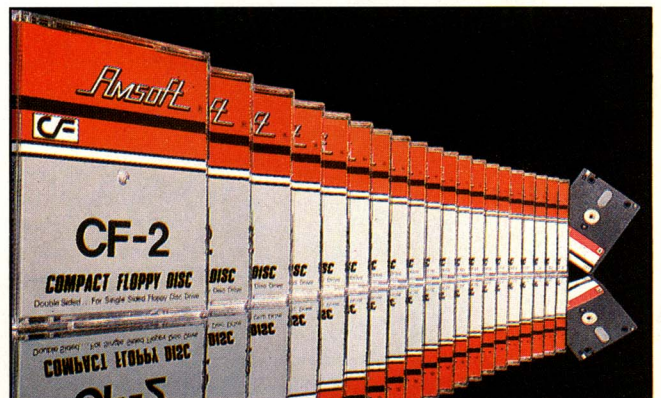

Send coupon to: Marketing Dept. Amstrad Consumer Electronics Plc, Brentwood House, 169 Kings Road, Brentwood, Essex. CM14 4EF

Name .....

Address .....

Post code ..... Tel. No. ....

CF-2  
PACK OF 5

CF-2  
PACK OF 10

Other quantity (please state) .....

(PLEASE DO NOT SEND ANY MONEY WITH THIS COUPON)

8+/4



# FULL STEAM AHEAD

The launch of LocoScript 2 is now only a couple of weeks away. Ben Taylor has been to Dorking, home of Locomotive Software, to get a sneak preview of LocoScript 2, and also to ask their marketing manager Howard Fisher how it was that LocoScript came about in the first place.

“It’s a strange thought, but five years ago all the key figures responsible for the design of the biggest-selling word processor ever all worked for one company,” said Locomotive’s

when Alan Sugar turned his mind towards the PCW as his follow up, he should go back to Locomotive for the software and MEJ for the hardware.

## A machine is born

“Roughly speaking, it was nine months from Amstrad saying to us, ‘Design us a word processor,’ to us saying, ‘Here are the discs,’” said Fisher. There were five people in on the act, although not all of them were full time.

The brains behind LocoScript were Locomotive’s two founders. Chris Hall was responsible for the design of the product, and Richard Clayton managed the team of programmers doing the implementation. The PCW software and hardware influenced each other. For instance, the screen was given 90 columns rather than the usual 80 at Locomotive’s request.

“People say that Amstrad machines are not advanced – that’s rubbish,” Fisher went on. The prototype that MEJ produced for the PCW was a circuit board the same size as the PCW’s current one, but eight layers deep. It was called the GAS board (for ‘Gate Array Simulator’), and packing that down into a PCW took some pretty advanced techniques.

Fisher doesn’t know how many PCWs have sold – “somewhere over a quarter of a million,” he reckoned – but does know that from all the Amstrad machines over one million copies of Locomotive’s various BASICs have been shipped. The number of different national versions of LocoScript runs well into double figures, catering for most major European languages. The American version had to be called ‘LocaScript’ because of connotations that ‘loco’ has over there.

After the PCW launch, Locomotive were kept busy developing software for the

Amstrad PC 1512. As soon as this was done, they cracked down to producing LocoMail and LocoSpell, which emerged respectively in September and December 1986. About the same time, LocoScript 2 started to become more than just ‘vapourware’ (as unwritten software is sometimes called).

Although Amstrad-based software is the most visible part of Locomotive’s products, they do a lot of work for other companies too. When Richard Branson crossed the Atlantic on his Virgin Challenger – and sank – he was carrying a Locomotive-programmed Microscribe portable.

## Past, present and future

An evangelical look came into Fisher’s eye at this point, as he began to talk LocoScript. “With LocoScript 2 we’ve tried to leave the user interface much the same. We don’t want users to have to learn a whole new product, although we have rationalised a lot of the idiosyncracies to make it easier for newcomers.” Locomotive’s technical author, Jean Gilmour, has written a long and comprehensive new manual, which should please everybody at last.

Although LocoScript 2 is based on LocoScript 1, the changes are significant enough that LocoMail and LocoSpell will not work with LocoScript 2. Third party suppliers who market add-ons for LocoScript (like SuperType) will find their products no longer work. New versions of LocoMail and LocoSpell will be available for LocoScript 2, and people who have bought the old versions can upgrade free of charge if they return their master discs at the same time as buying LocoScript 2.

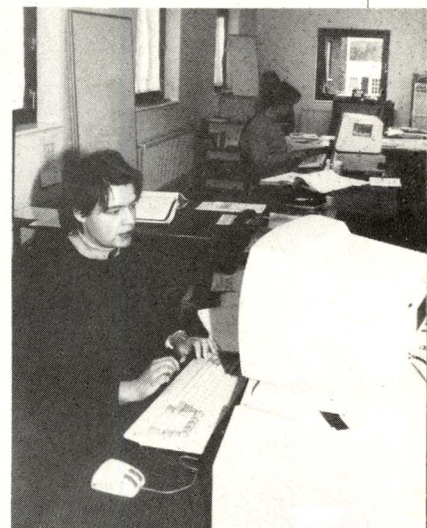

▲ Where it all happens ... Locomotive’s programming area

“We don’t see LocoScript 2 as the ultimate word processor, or even the last word in LocoScript,” Fisher added. “There are always improvements that can be made, and there will be a LocoScript 3 sometime. That’s why we are happy to charge a relatively low price for number 2. Basically, apart from those who never use LocoScript for anything except the very simplest letters, every single LocoScript user is going to benefit from LocoScript 2.”

And to the future? Sometime there will be a LocoScript for the IBM PC, but if Locomotive do know of Amstrad’s plans for a new model of PCW, Fisher was being coy. “LocoScript 2 will not be bundled with future sales of the PCW8256 or 8512,” he said. But if he were an Amstrad marketing man, would he want to bundle LocoScript 2 with some machine? “Oh yes. Definitely.” Watch this space... EXIT



▲ Locomotive’s Howard Fisher

Howard Fisher.

Data Recall, as that company was called, obviously didn’t know what they had. They were bought up by another company, and the disgruntled staff gradually went their separate ways. Some formed a hardware company called MEJ Electronics, some formed Locomotive Software. Fisher himself went to work for Acorn in Cambridge.

Locomotive’s first product, back in 1982, was Mallard BASIC, written under contract for Acorn and their BBC micro’s Z80 second processor. Not long afterwards, Amstrad came on the scene – they were developing their CPC 464 home micro, and Locomotive were asked to write the BASIC for that.

The CPC machines were a great success, the hardware and the software winning praise from all corners. It was only natural that

## LOCOSCRIPT 2

LocoScript 2 will cost £19.95, and will be available at the end of March. If you are interested in more details, send an SAE to Locomotive at Allen Court, High Street, Dorking, Surrey RH4 1YL. The main new features of LocoScript 2 will be:

- ▶ There is a ‘jump to page’ command which can zip to any page in a document without all the agonising scrolling.
- ▶ You can send output to printers other than the standard one, via the serial/parallel interface.
- ▶ There are 448 basic characters, including a full modern Greek set. There are 15 accent characters, any of which can be used with any character.

- ▶ The character set on the standard printer has been redesigned, with a new ‘W’ among other things. There are 10 ‘user-definable’ characters for specialist applications.

- ▶ The contents of Blocks is not lost when a document is exited, so they can be used for inter-document moves.
- ▶ The Find/Exchange command can locate text irrespective of case, and set the capital letters appropriately on an exchange.
- ▶ The menus have been simplified, and in particular setting up headers, footers and page sizes has been redesigned.



LocoScript user. . .



Instead of this . . .

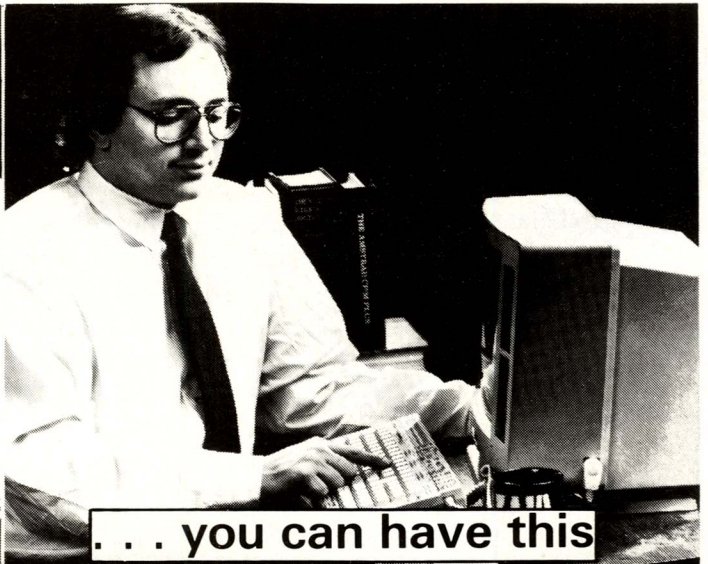

. . . you can have this



£6.99

## MENU-MATE™ . . . THE FACTS AT YOUR FINGERTIPS

Never forget another command with Menu-mate™ Templates to remind you. Save time and end frustration because commands and simple instructions are at your fingertips for quick and easy reference.

Richman Software's Menu-Mate™ is easier to use than books or reference cards, the facts are complete, properly organised to help you and available at a glance.

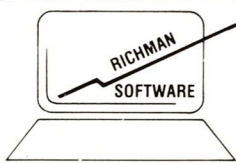

The first in a range of keyboard templates for popular micros and software.

PATENT APPLIED

Select options instantly, by-pass the menus. Why press six keys when two will do the same job?

See the exact appearance of your letter *as you type it* . . . no more guesswork.

Throw away the manual! Menu-Mate™ gives simple instructions on cutting, copying and pasting blocks and phrases for instant reference.

Never lose work because it wasn't saved. Menu-Mate™ acts as a constant reminder *and shows you how!*

Shows special features of LocoScript almost unknown.

PCW is a trademark of Amstrad plc  
Locoscript is a trademark of Locomotive Software.  
Menu-Mate is a trademark of Richman Software

Menu-Mate™ is precision cut to fit the PCW Keyboard exactly. This allows stability and easy removal.

Special introductory price of £6.99 + p&p includes free LocoScript guide.

Generous discounts available for bulk purchase.

Call for quantity discounts or quotations on custom made templates to meet your special needs.

**ORDER NOW ON THE FORM BELOW AND KEEP THE JOY IN YOUR JOYCE!**

Please make Chq/P.O. payable to:  
Richman Software, 14-16 Little Walk, Harlow,  
Essex, CM20 1HY. Tel: (0279) 25401.

Please send . . . . . Menu-Mate®/s at £6.99 + £1.25 p&p to:

Name: .....

Address: .....

Overseas add £4.00 p&p payable in Sterling.  
Allow 21 days delivery  
Major credit cards accepted

8000 PLUS



**STOCKMARKET**

**£29.95 • Meridian Software • 01-850 7057**

The package consists of a 3" disc and 50 page booklet of instructions. The text is clear and well illustrated with drawings of the various menu options – the print may be rather small, but if you can read the share prices in the daily papers you won't need new glasses for this.

The main side of the disc contains the accounts program for recording details of purchases and sales of shares or other investments, as well as recording the balances in up to four cash accounts. Each file holds 50 entries which is plenty for the small investor. Once the basic details have been entered you can move on to recording dividends, yields and P/E (price/earnings) ratios. The last two are automatically updated each time you enter a revised price for the shareholdings. The menus for buying and selling contain user-defined default values for the costs involved ie stamp duty, commission and VAT. Total dealing costs, dividends and the portfolio value are shown when you list the account with provision to list dividends and cash transactions separately.

The entire program is menu driven. The main menu itemises the principal functions and leads on to an option menu which is accessed using the cursor keys. Data entry is virtually the only stage at which information has to be typed in directly. In most cases there is either a default answer or a predefined set of choice answers, all of which makes the program easy to use. It is impossible to exit from any part of the program without going through a save routine, and most of the default options in the menus are fail-safe which makes for safety but is slow.

Also on side 1 is a prices menu which enables the

# TAKING STOCK

David Frost looks at two packages to help Sid get the most from his British Gas shares

In the stockmarket accurate records and forecasts can make the difference between expensive failure and comfortable profits. Previously this was the preserve of the wealthy, but recent privatisation issues have brought share ownership to a much wider section of the community. The bulk of shares are still owned by the big institutions, but there are five million more shareholders now than ten years ago. Personal Equity Plans which started on 1st January are likely to spread share ownership still further. If you are a newcomer to share ownership or an experienced investor wishing to take a more active interest then one of the programs reviewed here may well be what you need.

▼ The Stockmarket plot of Pilkington prices over 10 weeks, showing the 5 and 13 week averages for recent dates. There is no facility for free text entry.

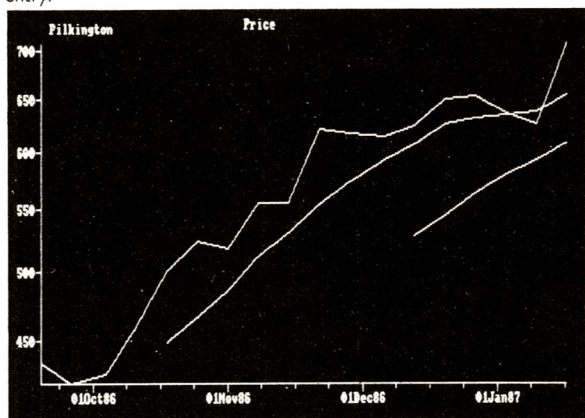

▼ The same share on the Sharemaster plot. Differences in plotting and data storage techniques result in the 5 and 13 week averages appearing for early dates too. Note the free text facility for adding labels.

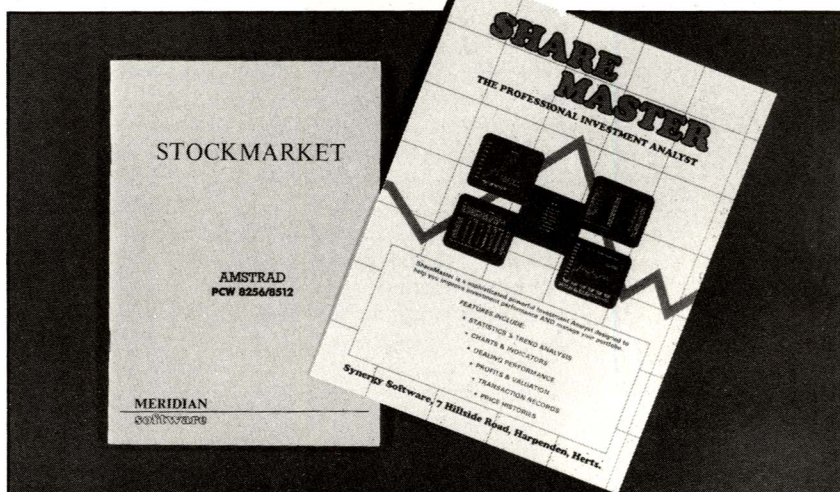
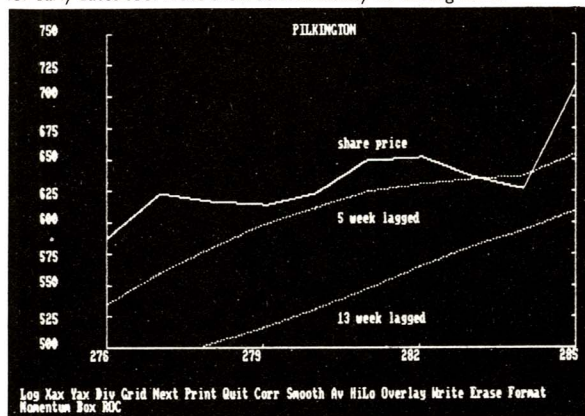

prices of up to twelve shares per file to be recorded for 260 dates. These shares need not be the same as those contained in the accounts menu for this part of Stockmarket is used to identify which shares to buy or sell and when. Side 2 of the disc contains the program for plotting the price movements of the selected shares. The most useful tool here is the ability to plot average prices over a period – you can choose the length of the period and decide whether to average at the middle or end.

**Personal Equity Plan (PEP)**

A recently introduced scheme which enables investors in the stock market to receive dividends free of tax. Capital Gains are tax free too.

**PLUSES**

- Comprehensive and well written manual
- Records shareholdings and dividends
- Permits forecasting of prices by moving average method
- Bank or Building Society accounts can be recorded

**MINUSES**

- Data cannot be output in form compatible with tax return
- Fail-safe default values slow program down

**RANGE OF FEATURES** ■■■□□

**EASE OF USE** ■■■■□

**PERFORMANCE** ■■■□□

**DOCUMENTATION** ■■■■□

**8000 PLUS VALUE VERDICT** ■■■■□



# A millionaire overnight

The art of making money on the Stock Exchange lies in knowing when to buy and sell. There are two ways of assessing this.

**Company Performance:** theoretically the value of a company's shares should reflect its trading performance but this is not always so. For instance the published accounts are usually months out of date and many other political and market factors can have sudden and unpredictable effects on profits. City stockbrokers maintain extensive research departments who assess all these factors before making recommendations to clients.

**Technical Analysis:** the alternative is

to disregard the company's performance and study the way its share price has moved. If buyers outnumber sellers the price rises and vice versa. Eventually someone will lose their nerve and the price will start to move the other way. Technical analysis looks at recent share performance and attempts to identify the point at which the reversal will occur and thus the time at which to buy or sell. Sharemaster has many features which help with this analysis, Stockmarket has one. There are several good books on technical analysis which you should study before using the method.

## SHAREMASTER

£99.95 • Synergy Software • 05827 2977

Sharemaster comes with loose leaf instruction manual, which is fundamentally well produced but has some irritating features. BBC computers and PCWs are covered in the instructions and the differences are not always obvious before you reach the end of the paragraph. At the back of the book newcomers to technical analysis will find a good description of how to use the charting indicators, and there is a useful section on trouble shooting too.

Sharemaster runs from CP/M but has insufficient room on the disc to hold the entire program. Some files are copied across as part of the installation process but CP/M must be restarted from scratch each time the program is run. This is a reflection of Sharemaster's greater facilities and the extra space they take up. Side 1 of the disc contains the main program, whilst side 2 has the data on it. Side 2 also contains some operating files, so a separate copy of side 2 must be made for each portfolio. Specimen files are included on the data side and with these it is easy to work through the book trying out all the functions.

At this stage the increased power of Sharemaster becomes apparent. Each portfolio holds up to 50 files which can be manipulated using six program modules covering different aspects of management and analysis, which makes the program easier and quicker to use than Stockmarket where the management and analysis files have to be kept separate. The Share Price Editor module is used to update prices and has a useful date prompt. Prices can be updated globally (ie. all the shares on the

same date) or by individual share. The second data entry module is the Deal Database – here you record details of purchases, sales and dividends relating to the portfolio. Dealing costs must be entered individually, and you can add textual notes about each file.

Once the data is entered you can begin to analyse it with the Charting mode. Prices can be charted over a selected period in various ways such as exponentially weighted curves, moving averages, point and figure charts, rate of change, momentum and HiLo. Different curves can be superimposed for comparative purposes. Care is needed to get the scaling correct, but once mastered this excellent facility is the heart of the

▼ A print from the Sharemaster Price Analysis mode showing Pilkington shares over the same period. Columns 3 and 4 are the lagged averages. The remaining four columns show selected trends averaged over 5 or 13 weeks.

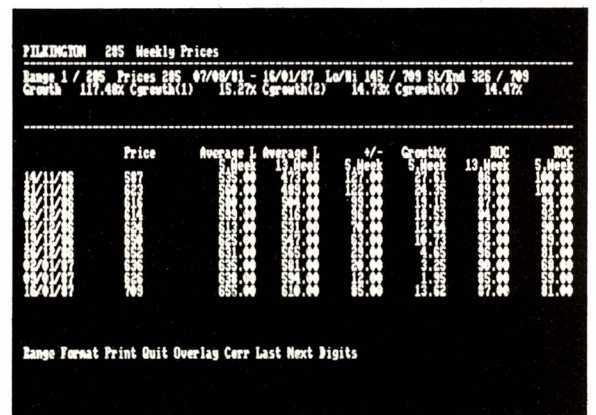

program if you intend to buy or sell shares based on technical analysis.

There is much more flexibility than in Stockmarket. A valuable tool is the Price Analysis mode which gives a tabular analysis of share price movements. The top half of the screen shows nine different bits of information about the share whilst the bottom half can be configured to show six columns of selected information. Details of another share can be displayed for comparison. As elsewhere in Sharemaster the user is given detailed control over the selection and display of information.

## Which one for me?

Sharemaster is significantly more powerful and versatile than Stockmarket, but given that it is more than three times the price this is hardly surprising. Whether the differential is worth it depends on what sort of shareholder you are.

Sharemaster is ideal if you are an active shareholder and fancy technical analysis as a means of managing your portfolio. It is also slightly easier and quicker to use if you have many share holdings.

On the other hand Stockmarket will be perfectly satisfactory for the newcomer to share ownership with a small portfolio, or if you prefer to buy and sell according to the advice given by your stockbroker or newspaper. Its analytical capability is quite adequate for a graphical display of share price movements and for buy/sell indicators based on moving averages.

Readers who struggle with income tax returns will note that neither program has the facility to print out dividends in the way the Inland Revenue requires, or do a selective print of capital gains in tax return format. Sadly the PCW is not powerful enough to handle the complex rules involved and you will still need to perform these functions with pencil, calculator and icepack.

## Stocks and shares

Stocks are a way in which the Government borrows money at fixed interest rates. You don't make much capital gain, but you shouldn't lose much either. Shares, on the other hand, are a riskier form of investment in which capital gain rather than income is the main aim. Share prices go down as well as up!

### PLUSES

- Comprehensive and well written manual
- Very powerful features for technical analysis of share price movements
- Good graphics

### MINUSES

- Data cannot be output in form compatible with tax return
- CP/M must be loaded every time

RANGE OF FEATURES   
EASE OF USE

PERFORMANCE   
DOCUMENTATION

8000 PLUS VALUE VERDICT

# Moving averages

The 'moving average' method is one of the most popular forms of analysis and can be done using either of the programs. When a falling average starts to rise it is usually a buy indicator

and likewise if a rising average starts to fall you should consider selling. 13 weeks is a common averaging period giving a reasonable margin of safety.



# Now

# NEWSDESK INTERNATIONAL

**AVAILABLE NOW!**

At long last it is here, the complete desktop publishing system for Amstrad PCW, its name — **NEWSDESK INTERNATIONAL**.

With the extensive experience gained from producing the unique PCW Light Pen, Mouse and Video Digitiser, The Electric Studio Products Limited are probably the best qualified to bring you this much sought after product.

**NEWSDESK INTERNATIONAL** allows you to use ASCII files created with Locoscript which can then be read in and structured into columns around your pictures and illustrations.

Text variations are possible using a variety of font styles and sizes, with numerous justification, offset, and pagination options.

In addition a graphics library is included on disc to make **NEWSDESK INTERNATIONAL** a stand alone product in its own right.

Control is via the cursor keys with the option of using either the ESP Light Pen or Mouse, with the package accepting digital input from Camera or Video recorder, via the P8 Video Digitiser.

Graphics creation is fully catered for by the inclusion of the latest version of our highly acclaimed "ART" Package, providing the user with a multitude of functions.

- SIMPLE AND EASY TO USE
- WINDOW SELECTION WITH ON SCREEN PROMPTS
- ALLOWS INPUT FROM LOCOSCRIPT FILES
- EASY MIXING OF TEXT AND GRAPHICS
- FULL A4 PAGE COMPOSITION
- FACILITY TO SELECT MULTIPLE COLUMN WIDTHS
- VARIABLE PARAGRAPH INDENT
- FULL JUSTIFICATION WITH RIGHT/LEFT/CENTRE AND MICRO OPTIONS
- CHOICE OF STANDARD OR PROPORTIONAL SPACING
- COMPREHENSIVE IMAGE MANIPULATION WITH RE-SCALING AND ROTATION
- 5 STANDARD FONT STYLES ALLOWING 3 DIFFERENT POINT SIZES
- FONT EDITOR FOR CREATION OR ALTERNATE STYLES
- SINGLE OR DOUBLE DENSITY OUTPUT

Up to now we have produced peripherals which have been acknowledged as the best products for the Amstrad PCW. We feel confident that **NEWSDESK INTERNATIONAL** will set the standard that other desktop publishing systems will be unable to match.

*We stand by our reputation ...*  
**THE BEST PRODUCTS AT THE BEST PRICES**

**AVAILABLE NOW**  
**ONLY £49.95**  
including VAT and P&P

**Sample layout of A4 page using NEWSDESK INTERNATIONAL**

## ORDER FORM

Please rush me:

- NEWSDESK INTERNATIONAL**  
Comprehensive desktop publishing system @ £49.95
- PC8256/8512 LIGHT PEN**  
Complete with Interface, 'ART' disk & Manual @ £79.95
- PC1512 LIGHT PEN**  
Complete with software @ £19.95
- PCW MOUSE**  
Complete Mouse graphics package @ £129.95
- MOUSE FONT MODULE**  
Now available @ £19.95
- VIDEO DIGITISER**  
The ultimate graphics input device. Choice of two models @ £99.95  
PCW 8256/8512  CPC 6128
- SNIP ART**  
Collection of digitised images for use with 'ART' package @ £14.95
- FONT EDITOR**  
Complete — for use with 'ART' package @ £19.95
- Please indicate version required:  
Light Pen  Mouse

Name ..... Mr/Mrs

Address .....

..... Post Code .....

Cheque/P.O. for £ ..... is enclosed  
Debit my Access/Visa Card No: .....

Expiry date .....

Signature .....

Please fill in and return to:

**THE ELECTRIC STUDIO**  
Unit 13, The Business Centre,  
Avenue One, Letchworth,  
Herts. SG6 2HB

**TRADE ENQUIRIES:**  
0462 675544 (Export Sales Only)  
0462 834864 (Home Sales Only)

**DIRECT ORDER HOTLINE:**

☎ 0462 675666

**THE ELECTRIC STUDIO**



# Suffolk Software

for the lowest prices you'll see anywhere.  
If you know what you want and how to use  
it, why pay more for PCW8256/8512  
software?

**LocoScript Audio Tutorial £6**  
**SuperCalc2 £38**  
**Cracker2 £36**  
**FlexiCollection £39**  
**dBASEII £88**  
**Cardbox £38**  
**Touch 'n Go £16**  
**Sage Popular Accounts £68**  
**Compact Accounts £138**  
**Camsoft Integrated Accounts £118**  
**MAP Accounts £118**  
**Companion £15**  
**Trivial Pursuit £18**  
**Hitchiker's Guide £19**

Please note we sell only the big name publisher supported software. So we don't pretend to offer expensive and unnecessary end-user support - hence the low, low prices. All prices include VAT and PP.

**Cheques and Postal orders only to**

**Suffolk Software**  
**1 Well Lane, Clare,**  
**Sudbury,**  
**Suffolk CO10 8NH**



**P**robably 90% of PCWs are used by only one person. Taking this to its logical conclusion, the person most likely to irreparably damage your files is yourself.

For example, you have an old disc which you now want to re-use for something else, so you put it in the drive and type 'ERA \*.\*'. Just as you've pressed 'Y' to confirm the command, the horrible truth dawns on you: it's the wrong disc. Outrageous? Well, such things have been known even in the 8000 Plus offices.

There is a way to protect yourself from your own folly, by making your files 'read-only'. Read-only files (also called 'write-protected' files) can be copied, printed and read, but not deleted.

The CP/M command that does all these is SET, and you will need to have the file SET.COM on your CP/M work disc. Suppose you want to protect a file called ACCOUNTS.FEB from accidental erasure; assuming SET.COM and ACCOUNTS.FEB are on the current disc, type

```
SET ACCOUNTS.FEB [RO]
```

Now if you try to delete it, with the command ERA ACCOUNTS.FEB, you will be told that it is protected

```
B>SET ACCOUNTS.FEB [RO]
B:ACCOUNTS.FEB set to directory (DIR), Read Only (RO)
B>ERA ACCOUNTS.FEB
B: ACCOUNTS.FEB Not erased, Read Only
B>SET ACCOUNTS.FEB [RW]
B:ACCOUNTS.FEB set to directory (DIR), Read Write (RW)
B>ERA ACCOUNTS.FEB
B>
```

▲ The steps in protecting a file from accidental erasure. Setting it back to [RW] allows it to be deleted later on.

(you will need to have the file ERASE.COM on your work disc too). Whole groups of files can be protected in one fell swoop using wildcards in filenames – SET \*.\* [RO] will protect every file on the disc.

If you want to unprotect a file which has been set to be read-only, the command is 'SET filename [RW]' (which sets it to 'Read-Write' status). You will now be able to delete that file again.

## Halt, who goes there!

So on to passwords. CP/M allows you to specify an individual password for each file on a disc, so that without knowing that password it is impossible to read or otherwise use that file.

Well, in theory that's the idea. In practice, the password security in files is stunningly easy to get round, and you shouldn't rely on it for any degree of real protection. If you *are* storing sensitive data on disc, the sensible thing to do is lock the discs up in a safe every night.

Before you can set up passwords for files, you have to tell CP/M that you intend to use passwords for files on your current disc. Supposing you are working with a disc in drive A, you must give the command

```
SET A:[PROTECT=ON]
```

Now you must also decide on a password for the disc. If you don't give the disc a password, anyone can turn off the file protection mechanism with the command SET [PROTECT=OFF]. If there is a disc password, you must know it to be able to turn protection off this way. So, if your password is to be 'DISC', the command would be

```
SET [PASSWORD=DISC]
```

# DO YOU WANT TO KNOW A SECRET?

If the GCHQ spy centre uses PCWs for their secret data, Ben Taylor has some advice for them

What kind of information do you hold on your PCW? The current disposition of the NATO forces? The Prime Minister's itinerary for the next month? Or maybe just your shopping list. Pause for a minute to think what mayhem would result if your data discs fell into the hands of terrorists, and ask yourself if you are being paranoid enough.

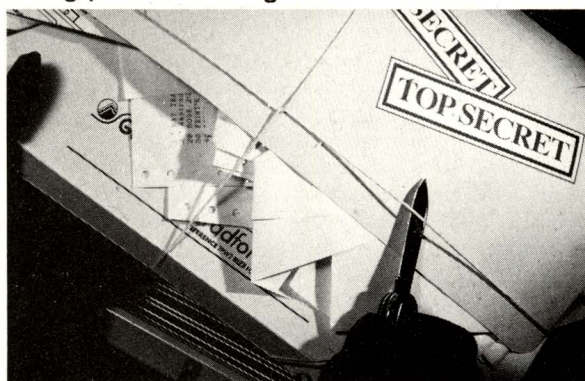

Whether you use upper or lower case letters is unimportant.

Now for the fun. To set a password 'Fred' on your weekly shopping list, the command would be

```
SET SHOPPING.LST [PASSWORD=FRED]
```

## Wildcards

If you have an operation which you want to do repeatedly on a large number of files, you will find that 'wildcards' make things a lot easier.

The name comes, unsurprisingly, from playing card games. For instance, if you play a joker in Canasta, you can let it stand for whatever card is convenient at the time, so it's said to be 'wild'.

In CP/M, which may seem at times like playing a game of chance, the asterisk is the wildcard. A few examples will make things clear: \*.COM means 'all files which end COM'. These wildcard filenames can be

used in many CP/M commands. ERA \*.\* means 'erase all files'. PIP M:=\*.COM means copy all files ending .COM from the current drive to the M drive.

Whereas \* stands for any name, no matter how many letters, you can use ? to stand for a single letter. For instance ERA PROG?.BAS will erase the files PROGA1.BAS, and PROG10.BAS, but will not erase PROG1.BAS or PROGRAM.BAS. In other words, if you use a question mark, it only matches names with exactly the right number of characters in the right places.



Try this out with a simple text file that you might want to list to the screen. Type TYPE SHOPPING.LST, which normally would print it on the screen, and CP/M pauses

```
A>SET [PROTECT=ON]
Label for drive A:
Directory  Passwds  Stamp  Stamp  Stamp
Label      Reqd    Create Access  Update
-----
A:LABEL    ,      on     off     off     off

A>SET [PASSWORD=DISC]
Label for drive A:
Directory  Passwds  Stamp  Stamp  Stamp
Label      Reqd    Create Access  Update
-----
A:LABEL    ,      on     off     off     off

Password = DISC
A>SET SHOPPING.LST [PASSWORD=FRED]
A:SHOPPING.LST Protection = READ, Password = FRED
A>
```

▲ The steps in protecting a file called SHOPPING.LST from prying eyes.

to ask you for the password. Get it right, and you're off, otherwise you get some typically friendly CP/M error message telling you that you are a spy.

You can set different passwords for each file if you like, or you can set up the same password for a number of files by using wildcard filenames. For instance, SET \*.\* [PASSWORD=FRED] gives the password Fred to all your files, which makes it a little easier on the grey cells.

You may decide that you don't mind anyone reading your files, but you want to prevent people you don't know from altering or erasing them. You can tell CP/M that the password is only needed for certain things the following ways:

- ```
SET SHOPPING.LST [PROTECT=READ]
- the password for the file is needed for reading the
  file, or doing anything at all to it.
SET SHOPPING.LST [PROTECT=WRITE]
- the password is needed for deleting, renaming or
  altering the file
```

## Um ... I forget

If you use passwords much, there's one thing you will find out pretty fast – unless you have an eidetic memory, you are bound to forget your passwords sometime. It does rather defeat the object of the exercise if you keep a piece of paper on the wall with all your passwords listed out.

True CP/M hackers probably know how to tweak the disc to get around the password protection, but LocoScript users have an easy way out. LocoScript, not being a CP/M program, does not follow CP/M's file conventions, and totally ignores passwords.

Therefore, if you have a file which you cannot access under CP/M, start LocoScript up and put in the disc with the CP/M files. When you press the 'fl Disc change' key you will see all your CP/M files listed out under group 0.

All you have to do is copy the protected file into a new file in the same group. With the cursor highlight bar over the file in question, press [F3], and [ENTER] to leave the copied file in group 0. Give it a new name, and erase the old file. When you restart CP/M you will find that you can access the new file quite normally.

- ```
SET SHOPPING.LST [PROTECT=DELETE]
- the password is only needed to delete the file
SET SHOPPING.LST [PROTECT=NONE]
- remove the password altogether
```

In all these cases, before the changes are done you will be asked to give the old password, just to prove that you really are the owner of the files.

If you want to set a new password for a file, it is easy enough as long as you again know the old password.

SET SHOPPING.LST [PASSWORD=BILL] will change the password to Bill, as but will ask you to enter the old one (Fred) to preserve security. To remove a password altogether, you effectively set it to be blank:

```
A>TYPE SHOPPING.LST

Password:
CP/M Error On A: Password Error
BDOS Function = 15 File = SHOPPING.LST
A>
A>TYPE SHOPPING.LST

Password:
Salt & Vinegar crisps
Marnite
Yorkie bar -- extremely large
Nutrition guidebook
A>
```

▲ The result of getting a password wrong, followed by a corrected attempt. The passwords are not shown as you type them.

## Default passwords

CP/M is a program we all know and love for its logical design. Having told you all about how passwords work, it will not surprise you to learn that there is a CP/M command to bypass them.

Suppose you have set up all files on your disc to have the password Fred. It gets a bit tedious to have to type Fred whenever you want to use a file, so there is a command to do it for you:

```
SET [DEFAULT=FRED]
```

tells CP/M that Fred should be the first password to try in all cases. If, after giving this command, you try and access a file which you have protected with the password Fred, then CP/M will not even bother to ask you for a password. Only if you access a file with some other password will you be prompted to give it.

Of course, if you protect your files with a password and then set up a default to make life easier for yourself, you might as well not have a password at all.

## Passwords and CP/M programs

When you have tried to type out or erase a file with a password, you will see that CP/M pauses to ask you for the relevant password. This is fine, but unfortunately most programs that use files aren't as clever as that. For instance, BASIC will totally fail to load protected files, and NewWord will not recognise even them.

So to all intents and purposes, password-protected files are useless if you need to use them with anything other than the simple TYPE, ERASE, PIP commands and so on. Even so, passwords are quite fun to use, and will usually put off all but the most determined prying eye. **EXIT**



ONLY THE BRAVEST FLY....

# TOMAHAWK<sup>®</sup>



## AMSTRAD

BY D.K. MARSHALL  
ADAPTED BY DARRELL D.

**TOMAHAWK** – a stunningly realistic flight simulation that puts you in command of an Apache Advanced Attack helicopter. Flying low over a spectacular 3D real world display with over 7000 ground features – **TOMAHAWK** puts you in the hot seat.

Ground attack and air-to-air interception is the challenge – day or night in the thick of the battlefield. Your combat mission is to locate and destroy enemy ground forces. It could be science fiction – it isn't – the Apache is for real.... the meanest, deadliest combat helicopter ever. You have the weapons, the machine.... climb in and prepare for take off!

- Spectacular 3D cockpit view with over 7,000 ground features.
- Authentic aerobatic performance.
- Ground attack and air-to-air interception, with laser guided missiles, rockets and 30 mm gun.
- Doppler navigation and target tracking.
- Day/Night vision systems.
- Cloudy, Crosswinds, Turbulence.
- Pilot ratings – Trainee to Ace.
- Impressive sound effects. (CPC ONLY)
- Pilots Notes.

**TOMAHAWK**  
THE DEFINITIVE  
HELICOPTER SIMULATION  
NOW AVAILABLE ON  
THE AMSTRAD PCW  
8256/8512



CPC Screen Pics

FOR ALL THE AMSTRAD CPC AND PCW RANGE

### SPECTRUM

- TT Racer 48/128K  £9.95  
Tomahawk 48/128K  £9.95  
Fighter Pilot 48K  £7.95  
Night Gunner 48K  £6.95

### COMMODORE 64

- Fighter Pilot  £9.95  
Fighter Pilot Disk  £14.95  
Tomahawk  £9.95  
Tomahawk Disk  £14.95

### ATARI

- Fighter Pilot  £9.95  
Fighter Pilot Disk  £12.95  
Tomahawk  £9.95  
Tomahawk Disk  £14.95

### AMSTRAD CPC 464, 664, 6128

- TT Racer  £9.95  
TT Racer Disk  £14.95  
Night Gunner  £7.95  
Night Gunner Disk  £13.95  
Tomahawk  £9.95  
Tomahawk Disk  £14.95  
Fighter Pilot  £8.95  
Fighter Pilot Disk  £13.95

### AMSTRAD PCW 8256/8512

- Tomahawk Disk  £19.95

VAT and p.&p. inclusive within UK  
(overseas inc. 55p per cassette)

Tele Sales  
(0276) 684959



Please debit my Access/Visa card no.

Expiry date \_\_\_\_\_

Cheques made payable to Digital Integration Ltd

I enclose a cheque/P.O. for \_\_\_\_\_ Total

Name \_\_\_\_\_

Address \_\_\_\_\_

Please send to

**DIGITAL  
INTEGRATION**



Watchmoor Trade Centre,  
Watchmoor Road,  
Camberley, Surrey  
GU15 3AJ

**Trade and Export enquiries  
welcome. Lifetime Guarantee.**



# SEEING THE LIGHT

The only computer you can use in schools is the BBC. Right? Wrong. History teacher David Gladden reveals how he saw the light.

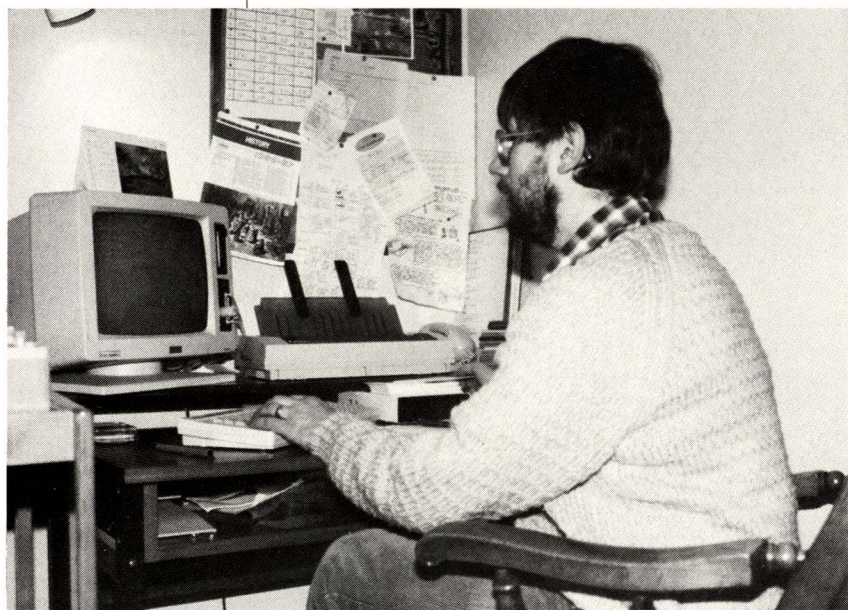

**B**uying an Amstrad 8256 did not change my life. In fact it had changed two weeks earlier when a large lump of wood flew from a lathe blinding me in the left eye. Fortunately, my profession as a teacher of History was not seriously endangered by the disability I had unwittingly acquired.

Following surgery and a period in hospital however I found myself in an enforced convalescence with time on my hands. Intending nothing more purposeful than providing myself with a therapeutic means of coming to terms with a suddenly reduced visual perspective on the world, I bought an Amstrad. In a month I had lost one means of viewing the world but had found another.

Such was my 'conversion' to the benefits of the new technology. Until that time I had long regarded it with suspicion in relation to my teaching and management role as Head of Department in a large 11-18 comprehensive school. I felt like a modern St. Paul in a curiously reworked account of his conversion on the road to Damascus.

## A class of its own

Having mastered the intricacies of LocoScript and negotiated the quagmire of the Amstrad Manual I returned to work, and like the biblical Paul set about using my new found powers. I began by rationalising those endless, tiresome, but vital administrative tasks with which all middle managers in secondary schools are besieged: the production of set lists, timetables, letters to parents of various kinds of naughty and nice pupils, minutes of meetings, reports, assessments, syllabuses and so on and so forth.

"Office paper is a thing of the past!" I explained to a worried Headmaster who had seen me emptying the contents of my filing cabinet into the school skip the previous day. He remained worried until he began to receive copies of History department correspondence, memos and minutes which were both unusually legible by normal school standards and evidently could be updated overnight in the annoyingly inevitable event of his discovery of 'mistakes' in the first draft.

My contributions to the twice monthly school newsletter became the envy of the School Office; using LocoScript's Layout facilities I was able to produce copy in print columns which did not require retyping. I had, in short, not only ensured a considerable future time saving, but had also streamlined my office administration.

Using the program Money Manager (from Connect Systems) to monitor the relatively simple accounts of the Department in later months I was able to note with satisfaction via its graphical displays that spending on stationery items had begun to fall during my second term using the computer.

My night time labours in achieving these advances were at first regarded with mild amusement by many of my colleagues in the Staffroom. The children I taught however were fascinated when they came across examples of work compiled on 'Sir's new toy'; from its acquisition I had used it to produce teaching notes, worksheets, labels, exam papers and the like.

Using a combination of LocoScript's wide range of keyboard characters and varying the line pitch I found I could reproduce on paper virtually any of the work that I would normally have done on the blackboard. This could then either be printed through the school's reproduction facilities or alternatively it could be photocopied onto acetate sheets for use with overhead projectors.

Correcting and adding to my resource bank became a simple matter – a task which in the past I frequently ignored because of the scale of the job. Later I bought a copy of LocoSpell to help me spot and correct typing errors in long runs of resource work. I almost regret this purchase because searching for examples of Sir's bad spelling in early sheets was a very popular activity amongst the children. In fact classes had scarcely noticed how easily they absorbed new information and tasks.

My own enthusiasm for the technology I had embraced was actually shared by the children. This straightforward fact led me to realise that computers had a role to play not simply in preparing History lessons but in the teaching itself.

## To BBC or not to BBC

In all these exciting lesson developments I was of course hampered by the fact that my school, in common with most other schools in Britain, uses the BBC/Amstrad



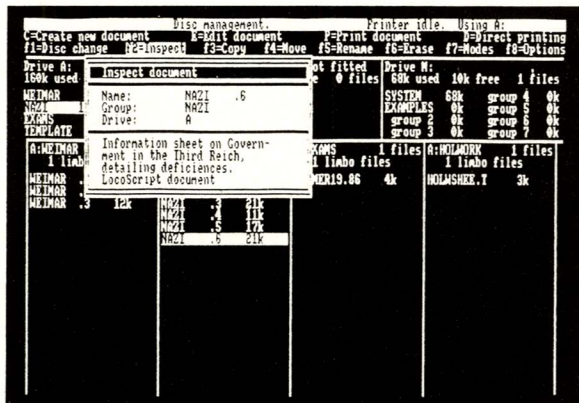

▲ Each school year has its own discs, on which are stored resource sheets and past exams. Every entry in the resource bank has a full identifier text.

machine with a 5 $\frac{1}{4}$ " disc drive. All the programs bought for school use were therefore unusable on the Amstrad at home; this was particularly frustrating on those programs which required setting up and interpreting for children's use.

Until, that is, I discovered the potential of the InterGem second disc interface for the PCW. This not only allowed me to connect a 5 $\frac{1}{4}$ " drive from my PCW but also gave me the software to read and write discs originally formatted for the BBC micro.

The InterGem program proved easy to learn and operate, providing step by step instructions for computer novices. It gave me the chance, in particular, to refine and develop the KWIRS database used in my classes. This program, because it involved the tiresome task of keying in a seemingly endless string of records was better tackled at home where I was unlikely to be interrupted by cleaners and caretakers, and where I could make a cup of coffee after 5 o'clock if I wanted to!

Despite these considerable advances there are still difficulties. The software does not enable the PCW to actually run programs written for the BBC. In addition because the machine's second drive is configured for double density discs any working data compiled on these has to be transferred to a single density format on a BBC double drive at school. A time consuming activity!

This problem of incompatibility, which I have only partly been able to overcome, is certainly a reason for Amstrad's apparent failure to date to capture a larger share of the educational market. The issue of compatibility, however is only one of several reasons for this disappointing performance.

BBC to Amstrad PCW File Transfer Utility.  
©1986 Dynamic Data Technology Ltd.

Is your BBC disc :-

- a) Single sided.
- b) Double sided.

Please answer 'a' or 'b'.

Please insert your BBC disc into drive b:  
your CP/M disc to copy files to into drive a:  
and press any key.

▲ Proof positive that the PCW actually can read BBC discs

Most local Education Authorities have stuck rigidly to their earlier decision to standardise on the BBC machines. These machines are undoubtedly excellent for the educational functions for which they are largely used in schools. Nonetheless, the relatively paltry RAM capacity of even the Master series machine and the complete dearth of compatible business software often

## The thrill of it all

Armed with my rudimentary understanding of computing and fired with the kind of enthusiasm I had seen in the children, I bought a number of educational programs for use on the school machines. I watched as my hunch paid off; children experienced life as settlers in the American West of the 1850s, discussing and solving the problems presented to them on screen (Waggons West by Tressell, and The American West by Longman CIC).

Other children were asked to become explorers and chart the New World of the 1500s with the difficulties and dangers that such a task would involve (Into the Unknown by Tressell). Even sixth formers were asked to test their understanding of British foreign policy in the nineteenth

century in front of the computer (Disraeli and the Eastern Question by Longman CIC).

One class of children was given the task of compiling a database of information on The Romans and then using the search facilities of the program to produce a display (KWIRS by the School of Librarianship and Information Studies in Aberdeen).

The enjoyment gained by the children in all these exercises was equalled only by the skills practised and the information absorbed. Although this classroom work was not done on the Amstrad PCW, the machine must be given much of the credit for inspiring the change in my Department's teaching methods.

reduces senior managers in school to writing their own programs in an attempt to rationalise administration.

These well meaning plans are doomed not only because of the inevitable deficiencies in the programs but because they have to run on BBC machines which by definition in a successful school are under constant use by children during the working day. Trade union agreements on the demarcation of clerical tasks amongst non-teaching staff further ensure that such access as exists to the available interfaces cannot be effectively exploited.

Consequently, those Heads and their Deputies who have tried to computerise their administration have had almost entirely negative experiences. Despite the fact that schools across the country account for a major annual slice of government revenue they are one of the few remaining institutions, in either the public or private sectors, in which computers still retain only a minimal administrative role.

There is a system which can be made to accept software written for the BBC machines and which will put the school on-line with major databases providing up to date educational reports and information. Two Amstrad PCWs with 10MB hard discs complete with trained operators and some of the readily available, low cost, professionally written accounting, database and word processing software would release most schools from the inefficiency of paper based office work.

Those teachers who share my enthusiasm and decide to buy the machine will do so with their own money and will learn to use it in their own time. Until senior educational administrators are made fully aware of the potential of this machine to improve the vital, but often forgotten business aspects of school life, I will continue to play my new role as Paul among the Romans. I am winning converts but it is a slow process. Thank goodness there are no lions!

EXIT

## Are you a case?

Has your PCW revolutionised your life? Traumatized it? 'Case in Point' is a regular feature of 8000 Plus, and we are always looking for readers with interesting experiences to relate. If you use your PCW for something more than just running LocoScript, why not share your thoughts with a waiting world?

Try to keep things light but specific, with a fair smattering of hard facts

about the packages you use. If you've had a bad time with some software, don't be afraid to sound off - you could be saving other readers weeks of agony.

We are looking for articles of not more than 2000 words, for which we will pay our usual generous rates. Write to Case In Point, 8000 Plus, The Old Barn, Somerton, Somerset TA11 7PY







be set up and changed as required and it is not too difficult to call up the list of classifications when you forget what a 'Z' customer is.

A short form of the company name is also asked for, which can then be used to call up records for viewing, printing labels and contact lists of varying descriptions and detail. This short name can then be used to trace this customer through the rest of the module (in the sales ledger for example). This would seem to be very handy unless you happen to forget what the short form is and the classification it comes under in which case you have call up the whole ledger to find that particular record again. Mind you the Cavalier package is obviously for organised people who would not be likely to forget such valuable information.

### 'Creating' customers

Once your customers have been, in the words of the manual, 'created' (does God know about this?) the accounts section can swing into action allowing invoices to be posted, along with the more rewarding task of keeping track of the cheques and cash coming in.

NOMINAL LEDGER ACCOUNTS		BALANCE SHEET	
0100 FIXED ASSETS		1001 Trade Debtors	
0200 FIXED ASSETS DEPRECIATION		1002 profit	
1000 DEBTORS		1010 Sundry Debtors	
		1050 Purchases V.A.T.	
1100 STOCK		1101 Stock Balance	
1200 CASH IN HAND		1201 Bank Account	
		1250 Petty Cash	
2000 CREDITORS		2001 Trade Creditors	
		2010 Sundry Creditors	
		2050 Sales V.A.T.	

THERE ARE MORE - SHALL I DISPLAY THEM (y/n) █

▲ A screen from Intact, the accounts program

Statements can easily be called up using the short name or the account number. And of course you can quickly call up the one account most users should be watching, the list of debtors. A handy feature here is an easily placed query marker which can be set against an entry in the sales ledger where there is some sort of problem or special arrangement. This could save you the embarrassment of chasing bad debts if, for instance, the customer is awaiting a credit note or the credit terms have been extended.

Balance the entries

The situation in the purchase ledger is identical except you have to 'create' your suppliers. If you have your

### INSTOCK ● Stock Control and Invoicing ● £59.95

Instock comes on a separate disc although, like everything else it can be called up from the main menu. At first glance it seems to have all the sophistication of the Intact accounts package but perhaps not the same amount of flexibility.

It works on the same principle with the user have to create a part description first. This is a very thorough document covering fields for a product group, cost price ex VAT, selling price ex VAT, uplift group, bin location, supplier, supplier part no., VAT percentage, lead time in weeks, safety stock level, minimum stock and maximum stock. Last of all there is space for an alternative part number which allows you to make sure that your customer is offered a similar suitable part if what he ordered is not available.

At first sight the particular set-up might not ideally suit a user's particular needs. Companies who, for example, don't use bin numbers, could reuse that field for

## Advantages V Disruption

If you already have an accounts package, stock system or database in use, changing to a new system is going to need a lot of careful thought. With the Cavalier system, the advantages in being able to move from one module to another could overcome the short-term disruption for some users.

In the same way prospective users should not really be thinking about using their computer for anything but this package. It may be relatively simple to load everything up in the morning but it is very tiresome to switch over to Locoscript to write a quick memo and then come back again.

default accounts set up the program will tell you automatically the relevant account in the nominal or general ledger that any entry should go to.

You can move easily into the nominal ledger section itself where you can post journal entries to the ledger (which have to balance first) and move and allocate entries over other accounts. Throughout this process a sub-total is displayed to make it easy to see what you are doing. You can also select an option to enter details into the cash book.

### Deciphering it all

Those who understand these things can put their fingers on all the relevant information to analyse the company's performance in a variety of ways. There would seem to be enough here to keep the accountants happy with Balance Sheet, Profit and Loss, Fixed Assets, Depreciation, Stock Balance and Property Accounts.

The last option in this section allows for the cleaning up of the accounts, audit reports, trial balances, closing the nominal ledger at whatever regular period takes your fancy and the end of year closing of the nominal accounts.

On the unexpanded 8256 there is not room to carry this section directly on to memory and in fact for anyone hoping to use the entire package it would be advisable having the bigger memory. That means that the whole lot could be fed in first thing in the morning and there would be no need to be constantly switching discs especially as the discs themselves could be better marked to help the new user.

### JARGON!

In line with our policy of cutting computer jargon to a minimum, we present a few simple explanations of that other famous style of jargon - Accountant-Speak. A word of warning however: if you don't already know most of these words you may want to think carefully about finding out a bit more about them before you buy a sophisticated piece of software like the Cavalier package.

### SALES LEDGER

The ledger that people like to look at. Here a regular record is kept of the company's sales with each customer given a separate account. It therefore also tells you how much you are owed.

#### PLUSES

- Covers most needs
- Works well in the whole package
- Flexible

#### MINUSES

- Perhaps too sophisticated for some small businesses
- Needs careful preplanning

RANGE OF FEATURES   
EASE OF USE

PERFORMANCE   
DOCUMENTATION

8000 PLUS VALUE VERDICT

something quite different to adapt it to their needs. The manual suggests taking some time in setting up to see how the system works with regard to a particular business and more importantly how to take best advantage of the more sophisticated aspects of the program. Wise advice.

One useful feature is an average cost worked out from the starting point of the cost price listed at this time and updated automatically from the total cost price which you would input every time you log goods into stock, a relatively simple exercise.

### Your horoscope

Potentially the most exciting part of the program would seem to be the Suppliers Orders section. This could be regarded as a horoscope for stock buying, although with a greatly improved chance of success. It looks at the average demand for a particular part and then suggests what order should be placed with the supplier. ▶

### PURCHASE LEDGER

The ledger that people should look at. Here the purchases are recorded and you discover where all the money you made in the sales ledger goes to.

### NOMINAL OR GENERAL LEDGER

The ledger that brings these two together so that you can, amongst many other things, find out how much you are making - or losing.



# ONTEST

## POSTING

It really means adding a piece of information to an account but it could be what you would be doing with your neatly set-out, fully completed accounts when you send them to your accountant at the end of the year instead of taking round a barrow-load of bits of paper as you usually do without an accounts package.

It does not just produce a simple average as the program takes more consideration of more recent demand so you are not liable to be caught out by the sudden success of a particular product. It also takes into account the lead time and the safety stock set in the stock record so it would be wise to make sure that these

```

CREATE STOCK RECORD
PART NUMBER : 1

PART DESCRIPTION [ ]
PRODUCT GROUP [ ]
COST PRICE EX VAT 0.00] AVERAGE COST 0.00
SELLING PRICE EX VAT 0.00]
UPHOLD GROUP [ ]
DIA LOCATION [ ]
SUPPLIER [ ]
SUPPLIER PART NO. [ ]
VAT PERCENTAGE [15.00]
LEAD TIME IN WEEKS [0.00]
SAFETY STOCK IN WEEKS [0.00]
MIN STOCK LEVEL [1]
MAX STOCK LEVEL [9999]
ALTERNATIVE PART NO. [ ]

STOCK LEVEL 0 BACKORDERS 0 SUPPLIER ORDERS 0
PRODUCT AGE 0 WEEKS DEMAND THIS WEEK 0
DEMAND HISTORY -6 -5 -4 -3 -2 -1 TOTAL
0 0 0 0 0 0 0
    
```

▲ A screen from Instock, the stock controller

are as accurately as possible. If they are not you cannot blame the program.

Admittedly it can take a few minutes to work this out,

but everything being equal it is likely to be considerably quicker and more accurate than trying to do this manually. It also gives some sort of scientific basis to what in many companies is an art rather than a craft.

Naturally the user cannot take this suggested list of orders purely at face value. Other factors which cannot be allowed for have to be taken into consideration. For example a company selling Christmas trees would have to look at the computer's predictions for the month of December very carefully. Of course it will just ignore new products that do not have a history but this would hopefully all be covered by old fashioned common sense.

The system does allow you to keep a close check on prices, printing a price list on request and applying a discount if requested. This makes it easy to produce a different price list for trade and retail customers. In the same way you can update the prices, setting the percentage you want the prices to rise by for the product or group you have chosen.

You also have a comprehensive ability to extract stock reports from the machine giving five different types of reports. It could take a while to decide what report actually suited your needs but at least the choice is there.

The other side of the package allows you to keep control of the output side of you stock. You are back again to the old task of 'creating' customers and there is the ability again to divide them up into type of business or geographic area.

You then move on to the order processing section which makes use of all the information processed through the stock control and customer update module. This allows you to process customer orders, checking as you go if the goods are in stock. It will print invoices including a friendly (or unfriendly) message from the company, which can be updated as regularly as you want. It also prints credit notes and a summary of all the invoices and credit notes raised in a particular period.

## PLUSES

- Comprehensive
- Works well as part of package
- Interesting features such as pricing and order suggestions.

## MINUSES

- Not very flexible
- Perhaps too sophisticated for many applications.
- Needs careful preplanning.

RANGE OF FEATURES ■■■■□  
EASE OF USE ■■■□□

PERFORMANCE ■■■■□  
DOCUMENTATION ■■■□□

8000 PLUS VALUE VERDICT ■■■■□

## TELEADD • Electronic Telephone and Address Book • £21.95

The last choice available is the Teleadd module used to keep track of names and addresses of both business contacts and family and friends. This is perhaps the least pleasing of the modules not seeming to have the flexibility that a databases would offer.

On the other hand if you do need to keep track of a large number of names and addresses and you are using the Intact or the Instock modules you would probably find it easier to use Teleadd which can virtually be called up at the press of a button than change to another database during the day.

```

AMEND ADDRESS

FULL NAME [ ] 8000 PLUS
ADDRESS LINE [ ] THE OLD BARN
ADDRESS LINE [ ] SOMERTON
ADDRESS LINE [ ] SOMERSET
POST CODE [ ] TA11 7PY
TELEPHONE [ ] 0458 74080
ADDRESS TYPE [ ] A
SHORT NAME [ ] 8000
    
```

▲ Teleadd, the address book

It is simple enough to use and seems to go into a fair amount of detail. As well as the usual address, telephone numbers and post code fields it asks for a short name and a single character classification for the purposes of calling up the relevant entry again.

## Remember your anniversary

Perhaps slightly more obscure is the ability to record anniversaries and birthdays. This comes under the same section where you can note the type of business of a company entry with a list of five contacts, which would be more useful in the serious business context where this package is likely to be used.

You can however opt for the list of the wedding anniversaries and birthdays of up to five loved ones. It does mean that you can call up a month and find out whose birthday or anniversary you had better not forget! You still have to be organised enough to check your reminder file, but if it did help someone remember these dates, that alone would make the expenditure on this module totally justified.

EXIT

## JOURNAL ENTRIES

An entry made as an adjustment to an account – for example to correct an error (heaven forbid).

## PLUSES

- Easily accessed from when used with package
- Provides for both private and business use.
- If Teleplus is added can be used to with other programs such as mail merge.

## MINUSES

- Not too important when all the customers and suppliers are already listed elsewhere.
- Not very flexible

RANGE OF FEATURES ■■■□□  
EASE OF USE ■■■□□

PERFORMANCE ■■■■□  
DOCUMENTATION ■■■□□

8000 PLUS VALUE VERDICT ■■■□□

## Summing up – the overall performance

RANGE OF FEATURES ■■■■□  
EASE OF USE ■■■□□

PERFORMANCE ■■■■□  
DOCUMENTATION ■■■□□

8000 PLUS VALUE VERDICT ■■■□□



# PROGRAMMERS!!! READ ON.....

## THE ARNOR



## THE 1st FULL IMPLEMENTATION

of the K&R standard on the Amstrad. Features include: optimising compiler★linker★PROTEXT program mode editor★I/O & math. libraries★full floating point★32 & 16 bit arithmetic★conditional compilation★macros★complete operators guide.....

**£79.95 (incl. VAT & P&P)**



## MAXAM II

### THE BEST ASSEMBLER

on the Amstrad, now under CP/M+ (as used by all the leading software houses.) **PLUS** the most powerful monitor ever seen under CP/M **AND** the PROTEXT program mode editor. Features include: Z80 assembler, now with macros★single stepping★conditional breakpoints★full expression evaluation★examine **ALL** memory banks★links to C★complete operators guide and much more..

**£79.95 (incl. VAT & P&P)**



## BCPL "FOR HUMANS NOT COMPUTERS"

(CWA MARCH '87)

The system programming language that is easy to learn and easy to use, the ARNOR BCPL is a full implementation, compiling to Z80 M/C code and is extremely fast. Also includes: debugging routines★I/O libraries guide★CP/M and AMSDOS version in same pack!

(incl. **FREE** ROM for CPC owners).

**£39.95 (incl. VAT & P&P)**

**ALL THREE PROGRAMS ON DISC FOR AMSTRAD PCW8256/8512 OR CPC 6128**

AVAILABLE NOW IN ALL GOOD COMPUTER SHOPS OR DIRECT...

24 HOUR CREDIT CARD NUMBER 01-684 8009 (6 LINES)

OR WRITE FOR FREE CATALOGUE

118 WHITEHORSE ROAD, CROYDON CR0 2JF





# SAFE AND SOUND

Five complete sets of PCW monitor and printer cabinets are waiting to be won!!! 8000 Plus and Mayfair Acoustics bring you the chance to straighten your neck, soothe your ears and scupper your enemies.

The Mayfair Acoustics cabinet set could be just what your PCW has been waiting for. It consists of two compact units: the MAC 1 printer cabinet and the MAC 1a monitor stand cum overnight lockup. Also thrown in is a smoked plastic screen filter to improve contrast – everything you could need to make your PCW quiet and safe.

The MAC set covers three main functions:

- 1** The monitor stand raises the PCW screen to eye level. This makes for a better ergonomic environment (sounds good, doesn't it?), since your neck, head and eyes are working in a more natural position.
- 2** The printer cabinet quietens the PCW printer. It is specially designed to allow continuous stationery to be fed into the printer even when it is totally enclosed, allowing you to print out your 500 page novel and conduct a rational conversation at the same time.
- 3** Inside the monitor stand you can lock up your discs and keyboard when you aren't using your PCW. No longer will you sit down to work in the morning to discover your dog mistook your discs for its breakfast.



## AND ALL YOU HAVE TO DO IS ...

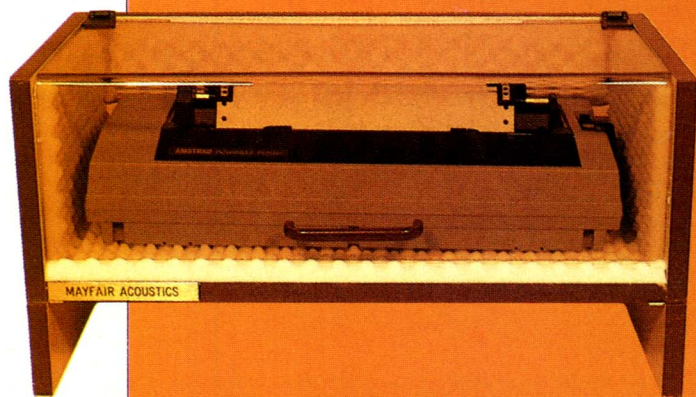

To win one of the five Mayfair Acoustics cabinet sets, you will have to arouse your dormant artistic skills.

What you have to do is design a cartoon and caption which is both funny and reasonably relevant to the prize. We'll forgive minor irrelevancies as long as the result makes us laugh!

The cartoon can be a one-off or a strip, hand drawn or computer designed. Don't be afraid that your total inability to draw anything other than a wobbly line will in any way count against you, just get those cartoons coming in.

Regrettably we are unable to return any entries, so if you need to keep the original artwork then make sure you only send us a photocopy. Send your entries to:

*Cartoon competition, 8000 Plus, The Old Barn, Somerton, Somerset TA11 7PY.*

### RULES

- 1** Entries must arrive no later than the 24th of April 1987, and the winners will be announced in the June issue of 8000 Plus.
- 2** The judges decision is final, and no correspondence will be entered into.



▲ The Official Amstrad Professional Users Club ▲

# AMSOFT AND MORE... DIRECT TO YOUR DOOR

Only the Official Professional User Club can offer you such a range of approved software from Amsoft, and other top manufacturers; and no shop could ever offer prices as low as these. But the savings don't stop here...

£6.95  
NON-MEMBERS  
**£5.95**  
MEMBERS



**PROTO**  
ARCHIVADOR de DISCOS de 3"

**PROTO DISCBOX**  
A compact box which stores upto 10 3" discs in a dust-free environment.

£29.95  
NON-MEMBERS  
**£25.45**  
MEMBERS

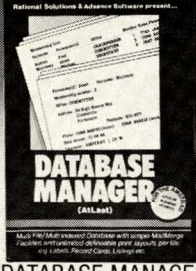

**DATABASE MANAGER**  
(All-Loss)

**DATABASE MANAGER**  
A sophisticated Database, superb for anyone who needs to merge correlate, or cross-relate files.

£24.95  
NON-MEMBERS  
**£20.95**  
MEMBERS



**Plan It**  
...the COMPLETE personal organiser

**PLAN-IT (FOR PCW)**  
The complete personal organiser with card index, financial diary, and personal accounts.

## JUST A SELECTION FROM OUR VAST RANGE

	NON MEMBERS	MEMBERS
LOCOMAIL		
LOCOSPELL		
Joint Purchase	£79.90	£61.90
3" FLOPPY DISKS	£2.99	£2.59
MONEY MANAGER	£29.95	£25.45
SUPERTYPE	£19.95	£17.95
DATASTORE	£39.95	£35.95
NEW! CARBON RIBBONS	£4.95	£4.25
TOMA HAWK (new game for PCW)	£19.95	£16.95

## TOP GAMES GIVING GREAT FUN AND VALUE

	NON MEMBERS	MEMBERS
SPACE INVADERS (The Classic)	£12.95	£11.00
TRIVIA (the "Boardgame")	£14.95	£12.70
BATMAN (Super Adventure)	£14.95	£12.70

ARE YOU A MEMBER OF LAWLINE? IF NOT, RING US FOR DETAILS.

**ORDER ACTION LINE · DIAL 091 567 3395 NOW**

For really fast attention, order now by phone (24 hour service) quoting Access or Visa number. Or fill in the coupon below.



### WANT TO SAVE A FORTUNE ON SOFTWARE? THEN JOIN THE CLUB!

- △ Help Hotline for any technical help you need.
- △ 12 months Free subscription to Amstrad Professional Computing Magazine.
- △ 24 hour telephone ordering facility.
- △ Free monthly newsletter.
- △ Exclusive products for club members.
- △ Privileged preview of new products.
- △ Big prize competitions.
- △ Products delivered direct to your door.

### HOW TO JOIN THE CLUB

Simply fill in the coupon on the right and return it to us at the address shown, together with your remittance. We'll send you your special membership card, and you can start making savings straight away.

PLEASE SEND ME: PROTO DISCBOX  DATABASE MANAGER  PLAN-IT  (TICK BOX)

Items: \_\_\_\_\_ as listed from our range.

Yes, I want to enjoy the benefits of Amstrad Professional User's Club Membership - Please enrol me today. I enclose cheque/P.O. for £39.95. Please send details to:

NAME \_\_\_\_\_ 8000P2

ADDRESS \_\_\_\_\_



Access or Visa no: \_\_\_\_\_

Please allow up to 28 days for delivery. Offers subject to availability; all prices correct at time of going to press.

· POST TO ·

· OFFICIAL · AMSTRAD · USER · CLUB ·  
· VICTORIA HOUSE · P.O. BOX 10 ·  
· SUNDERLAND · SR1 3PY ·



# HSV COMPUTER SERVICES LIMITED

## CONTINUOUS STATIONERY

	QTY			
	250	500	1,000	2,000
9.5" x 11" 60 GSM MICRO-PERF ALL EDGES	£2.95	£4.95	£8.95	£14.95
TRUE A4 90 GSM MICRO-PERF ALL EDGES	5.25	8.75	14.95	—
TRUE A4 100 GSM VELLUM MICRO PERF ALL EDGES	6.50	9.95	16.25	—
TRUE A4 100 GSM VELLUM MICRO PERF ALL EDGES (Coloured - Cream, Blue or Grey)	7.25	13.50	25.50	—
LABELS 3.5" x 1.5" (1 across)	—	2.95	4.95	9.50
LABELS 4.0" x 1.5" (1 across)	—	3.25	5.50	10.50
LABELS 4.0" x 1.5" (2 across)	—	3.75	6.50	11.95
LABELS 2.75" x 1.5" (3 across)	—	2.75	4.50	8.50

## PRINTER RIBBONS

AMSTRAD 8512/8256	£3.95ea	AMSTRAD DMP2000	£3.95ea
AMSTRAD 8512/8256 (red, blue, green, brown, orange)	£4.95ea	AMSTRAD DMP3000	£3.95ea

## DUST COVERS

PCW 8512/8256 Set of 3	£7.50	PC1512 Set of 2	£9.50
CPC6128 Set of 2	£8.50		

## NEW PRICES

## DISKS

AMSOFT/MAXELL 3" CF2... 1 - £3.10 5 - £14.95 10 - £27.95  
5.25" DS/DD 48tpi... 10 - £6.95 20 - £13.00 30 - £19.00

## DISK STORAGE BOXES (3" Disks)

	Price Each
HINGED LID - Holds 10 (cased)	5.95
HINGED LID - Holds 14 (cased)	6.95
HINGED LID LOCKABLE - Holds 14 (cased)	8.95
HINGED LID LOCKABLE - Holds 28 (cased)	12.95

**ALL OUR PRICES INCLUDE CARRIAGE & VAT - NO EXTRAS TO PAY!**

HSV COMPUTER SERVICES LIMITED, 40-42 New Market Square, Basingstoke, Hants RG21 1HS

CREDIT CARD HOTLINE (0256) 463507

# HSV

## Thinking of PLAYING THE STOCKMARKET..... then consider one of the INVESTMENT ANALYSTS from Synergy Software

SHAREMASTER (IBM PC/Amstrad PC1512 & Compatibles, Amstrad PCW 8256/8512 & BBC Micro)

ShareMaster is the ultimate investment analyst, charting and reporting system for the BBC and Amstrad PCW computers. A more powerful IBM/Amstrad PC1512 version is now available.

Designed for the small or professional investor, ShareMaster is a powerful integrated system used for predicting the mood and direction of the stockmarket and analysing investment performance. The package employs a comprehensive range of advanced predictive and analytical measures to help you improve the timing and success of investment decisions. ShareMaster can analyse share prices, unit trusts, currencies, trade options, commodities or any other time based series and offers facilities not found in commercial systems costing many times its purchase price.

### MAIN FEATURES ...

\*Charting facilities include logarithmic/linear scaling, point & figure, linear regression, exponential curve smoothing, correlation, relative strength, comparisons, momentum, Rate of Change oscillators, moving averages, highs, lows, trendlines etc.

\*Profit Analysis facilities include Valuation, Performance Reporting, Single Share and Portfolio profit analysis, etc.

\*Numerical analysis facilities include a variety of indicators, comparisons and statistics for any selected price range.

ShareMaster has extensive database and file management features including Company Profile, Transaction Reporting, File Import & full editing facilities.

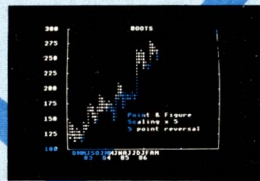

1. Raw Price Title
2. Bull Market
3. Technical Pattern
4. Profit & Relative
5. Price Relative
6. Rate-Of-Change
7. Volume Oscillator

Symbol	Price	Change	%
ASIA	12.00	0.00	0.00
AT&T	12.00	0.00	0.00
BHP	12.00	0.00	0.00
BP	12.00	0.00	0.00
BT	12.00	0.00	0.00
CA	12.00	0.00	0.00
CE	12.00	0.00	0.00
CH	12.00	0.00	0.00
CI	12.00	0.00	0.00
CL	12.00	0.00	0.00
CM	12.00	0.00	0.00
CO	12.00	0.00	0.00
CP	12.00	0.00	0.00
CR	12.00	0.00	0.00
CS	12.00	0.00	0.00
CU	12.00	0.00	0.00
CV	12.00	0.00	0.00
CW	12.00	0.00	0.00
CX	12.00	0.00	0.00
CY	12.00	0.00	0.00
CZ	12.00	0.00	0.00
DA	12.00	0.00	0.00
DB	12.00	0.00	0.00
DC	12.00	0.00	0.00
DD	12.00	0.00	0.00
DE	12.00	0.00	0.00
DF	12.00	0.00	0.00
DG	12.00	0.00	0.00
DH	12.00	0.00	0.00
DI	12.00	0.00	0.00
DJ	12.00	0.00	0.00
DK	12.00	0.00	0.00
DL	12.00	0.00	0.00
DM	12.00	0.00	0.00
DN	12.00	0.00	0.00
DO	12.00	0.00	0.00
DP	12.00	0.00	0.00
DQ	12.00	0.00	0.00
DR	12.00	0.00	0.00
DS	12.00	0.00	0.00
DT	12.00	0.00	0.00
DU	12.00	0.00	0.00
DV	12.00	0.00	0.00
DW	12.00	0.00	0.00
DX	12.00	0.00	0.00
DY	12.00	0.00	0.00
DZ	12.00	0.00	0.00

These are only a fraction of the facilities offered by ShareMaster. **ASK FOR OUR FREE COMPREHENSIVE BROCHURE.**

ShareMaster is exceptionally easy to use and is supplied with a 96 page operating manual which includes sections on interpreting the indicators provided and their use in investment strategy.

We are confident that no investment package can match ShareMaster in terms of facilities, performance, flexibility, ease of use and price. We firmly believe that every owner of ShareMaster will find it an indispensable investment aid and probably the best investment you will ever make.

Also available .... SHARE ANALYSER (BBC Micro only)

**'excellent - very highly recommended' - Which? Software Guide.**  
**'an excellent program' - Micro User.**

An easy to use budget reporting, analysis and charting package designed for the small investor. Ask for our FREE brochure.

**ORDER FORM** - BBC orders: please state 40 or 80 track. Dealer enquiries welcome. Prices include VAT and first class post. Orders despatched within 24 hours. Overseas orders send price inc. VAT for immediate airmail despatch. Cheque, Access, Visa and official educational orders accepted.

Please state computer type  Please tick

ShareMaster - all BBC & Amstrad PCW computers  £99.95

ShareMaster - IBM PC/Amstrad PC1512 & Compatibles  £149.95

Share Analyser - BBC B, B+ & Master computers  £24.95



Send cheque, P.O. etc to Synergy Software, Dept YA3, 7 Hillside Road, Harpenden, Herts AL5 4BS. (Tel. 05827-2977).



**PERSONAL TAX PLANNER**  
**£24.95 • Digita International • 03954**  
**5059**

Income Tax? Fun? O.K. We don't believe that either. But one thing you can say is that using Digita's Personal Tax Planner is more fun than filling out your tax return.

Putting it simply, Personal Tax Planner (PTP to its friends) is a program to fill out your tax return for you. When you run PTP, you are taken through a series of questions which are just like the sections of a tax return form. You type in details of your year's income, and PTP then produces a breakdown of how large a rebate you should claim. Equally, when you get your next bill, you can have a scientific basis for believing that the Inland Revenue has picked on you out of sheer spite.

Although PTP was written by a Chartered Accountant, the pricing of the program and its simplicity of use is such that it is aimed at 'the PCW owner in the street'.

**Many happy returns**

With PTP, you can work out the tax situation for a large number of people and store all the relevant details on disc. It would be conceivable to work out the tax for all your family and friends – a big plus for those really nose-y PCW owners.

If anything to do with income tax is easy, the program is relatively simple to use. It runs by a series of menus, and you choose which details you want to enter or amend. You are then faced with a series of simple questions, with yes/no answers – if a claim category applies to you, you are then pestered with questions until it extracts enough information.

It seems to cover all the options for the self employed, part-time work and of course the interest from your Swiss bank account. You don't even have to worry if you get it wrong the first time (not realising the question on widow's bereavement allowance referred to you for instance) as you can go back and amend the details using the Amend Data Option.

**What if I earned £100,000?**

PTP also gives you the handy facility of working out any number of "what if" options. If you were making £100,000 a year, you can discover that you would be paying £53,000 in tax.

The moment of truth comes when you pick 'Income tax computation' and the final dreadful figure appears. You can print this out if you are feeling brave. As married couples can be computed separately or together the program thoughtfully tells you at this stage which course is advisable, with how much you would gain or lose.

For those not in a pension scheme it also tells you what retirement annuity payments you need to take full advantage of the tax relief. The present package knows all the allowances for three tax years (84/85, 85/86, 86/87) but the makers intend to providing an update service that will keep all the relevant details correct no matter what the Chancellor throws at us. This might be a disadvantage to those who feel brave enough to change those details themselves but probably most users will be content to cough out £10 for an update.

The documentation is not infallible but seems to steer you through the intricacies well enough. There might not be enough details for some on how the country's tax system actually works, but many people are prepared to send off their tax return with a lot less background information.

# INCOME TAX CAN BE FUN

Do you have a nagging suspicion that the Inland Revenue are putting one over on you? Now you can check them out

With April 5th not far off, those of you who are enthusiastic (or masochistic) enough to really want to know what you are due to pay in income tax could well find this package well worth the investment of £20. For those who don't, just keep on writing "This can't be right" on your tax demands and send them to your accountant.

EXIT

<p><b>PLUSES</b></p> <ul style="list-style-type: none"> <li><input checked="" type="checkbox"/> Simple to use</li> <li><input checked="" type="checkbox"/> Needs a minimum knowledge of the tax laws.</li> <li><input checked="" type="checkbox"/> Keeps your income tax details in a place where you can find them again.</li> </ul>	<p><b>MINUSES</b></p> <ul style="list-style-type: none"> <li><input type="checkbox"/> Limited application. You could use only once a year.</li> <li><input type="checkbox"/> Costs £10 to update every year.</li> </ul>
<p><b>RANGE OF FEATURES</b> <input type="checkbox"/><input type="checkbox"/><input type="checkbox"/><input type="checkbox"/><input type="checkbox"/></p> <p><b>EASE OF USE</b> <input type="checkbox"/><input type="checkbox"/><input type="checkbox"/><input type="checkbox"/><input type="checkbox"/></p>	<p><b>PERFORMANCE</b> <input type="checkbox"/><input type="checkbox"/><input type="checkbox"/><input type="checkbox"/><input type="checkbox"/></p> <p><b>DOCUMENTATION</b> <input type="checkbox"/><input type="checkbox"/><input type="checkbox"/><input type="checkbox"/><input type="checkbox"/></p>
<p><b>8000 PLUS VALUE VERDICT</b> <input type="checkbox"/><input type="checkbox"/><input type="checkbox"/><input type="checkbox"/><input type="checkbox"/></p>	

Average Reader  
 -----  
 1985/86 Income Tax Computation  
 -----

Earned income		
-----		
Self:Employments or offices		100000
Wife:Employments or offices		6500
		-----
		106500
Personal allowances and reliefs		
-----		
Married mans allowance	3455	
Wifes earned income relief	2205	
	-----	
		5660
		-----
		100840
		=====
Taxable Income		
-----		
Tax payable		
-----		
Basic rate : 30 %	16200	4860.00
Higher rates : 40 %	3000	1200.00
: 45 %	5200	2340.00
: 50 %	7900	3950.00
: 55 %	7900	4345.00
: 60 %	60640	36384.00
	-----	
	100840	53079.00
	=====	
		53079.00
		=====
Tax payable		
-----		
Election for Separate taxation of wifes earnings would be beneficial. It would reduce tax liability by £538.50		
Husbands Retirement annuity premiums are £17500 less than the maximum relief		
Wifes Retirement annuity premiums are £1137 less than the maximum relief		



# HALF-TIME BREAK

Fed up with your favourite team losing? Harboured a secret crush on Pandora? Or just want to zap some aliens? Tony Flanagan investigates the new games releases.



Looks like those Geordies ▶ have been laying off the old Newcastle Broom. Meanwhile, Britain's greatest team – that's right, Wolves – fail to do themselves justice...again

## BRIAN CLOUGH'S FOOTBALL FORTUNES

£17.95 • CDS • 0302 21134

There are some people in the world, albeit a handful, who actually haven't heard of Brian Clough. A Tibetan monk I used to know, for example, thought he was an Anglo-Saxon deity. This, in a way, isn't far from the truth, particularly if you happen to belong to Nottingham Forest's dwindling minority (only joking Cloughie!).

Final League Table							
Club	Plgd	Won	Drawn	Lost	For	Agst	Pts
Newcastle	9	8	1	0	25	7	25
Everton	9	4	4	1	15	11	16
West Ham	9	4	3	2	5	6	15
Luton	9	3	5	1	13	9	14
Sheffield Wed	9	2	5	2	6	6	11
Wolves	9	2	5	2	8	12	11
Liverpool	9	1	3	5	3	7	6
Nottm. Forest	9	0	6	3	1	7	6
Spurs	9	0	5	4	2	7	5
Manchester Utd	9	0	5	4	3	9	5

However, as most of us know, Brian Clough is not a god at all, but a mere football manager, which brings us nicely round to the point. In Football Fortunes you take on this notoriously precarious role, dealing with many of the problems that old Cloughie himself encounters every day of his life.

### PLUSES

- ⊕ Well-planned game that integrates board and disk very well
- ⊕ Comprehensive menu
- ⊕ Detailed instructions; very user-friendly
- ⊕ Challenging and addictive

### MINUSES

- ⊖ Finding space for the board next to your computer
- ⊖ Brian Clough
- ⊖ The title

GRAPHICS  
ADDICTIVENESS



LASTING APPEAL  
VALUE VERDICT



But this is not just yer average computer game. The package combines disc and board, and comes with player cards, money and counters. And a nice package it is too, being colourful, compact and neatly designed.

The aim of the game is not simply to win the league or cup competitions but to 'excel in all aspects' of the job. These are many and various and include team selection, loans, transfers, and last but not least, players' wages (is it any wonder clubs are going bankrupt!?). You compete both against your fellow managers and the computer itself.

Football Fortunes has four levels and can be played by between two and five players. There are ten clubs to choose from and these include all the top names, except of course, that much maligned side, Wolverhampton Wanderers (You've guessed it – I'm their fan). However, you can key in your favourite team if any of the ten don't suit.

The game is run from a menu screen, which provides a comprehensive route to the different parts. The players can preview fixtures, play them, examine the current league table, read the Selection Problem and Manager's Luck cards and – to keep the counters trotting round the board – throw the die.

The player cards include all your favourite stars from Charlie Nicholas to such international superstars like Eric Gates (who he?). There are also blank cards on which you can write the names of any local nonentities you feel deserve some recognition.

The board gives the competing managers a range of different situations to deal with between matches. This might mean having to pay player's wages, bid for players who come up for auction or deal with sudden crises.

Graphically, the most exciting feature of the game is the teleprinter which gives out the scores. On the whole, the graphics are no big shakes but that really doesn't matter. What is really impressive is how compatible disk and board prove to be.

Brian Clough's Football Fortunes should give hours of good honest entertainment. A must for all genuine football fans, but terrace neanderthals steer clear: it might prove too cerebral.

## THE GROWING PAINS OF ADRIAN MOLE

£14.95 • Virgin games • 01 727 8070

Adrian Mole is a jumped-up middle-class adolescent with a terminal zit problem, a massive inferiority complex and an unhealthy dose of sexual frustration. But for that, he's an OK guy, which perhaps gives some clue to why Sue Townsend's books have been so successful. Through Adrian's eyes, we see the mad sad world in which we live in all its absurdity.

Anyone who has read Adrian's diaries will know that the books offer a wealth of wry comment on such topics as marriage, personal relationships, the education system



and the political follies of our time. In this computer version, programmed by Level 9 and produced by Mosaic, you get exactly the same.

Much of the material relies heavily on the original text. Knowledge of the books, however, will not automatically give you a better score. The object of the game is to make Adrian as popular as you can – an impossible feat you might think.

The game takes you through Adrian's diary entries over an eighteen-month period. This is a most eventful



time in his life. As well as coping with his lust/love for Pandora, he also has to cope with his parents' separation and (worse) their reunion. On top of this, there's his mother's pregnancy, the birth of his sister Rosie and the Falklands war. Worst of all perhaps are his painful encounters with his Australian dentist.

Progress through the diary is made by answering one of the three multiple questions that follow each segment of text. A percentage score indicates just how much of a sycophant you are (shouldn't be difficult for most people). Less than fifty will see you progress from part one to part two of the game.

At this point Adrian suffers a sudden attack of sensuality - oh to be an adolescent! It's not easy being a suburban schoolboy...

The text is well-written and genuinely funny. 'I will stop worrying about the size of my thing' is one of Adrian's New Year's resolutions. Though 'Now Windscale has been renamed Sellafield, I think they should rename the Lake District the Leak District' is perhaps my favourite.

The game comes in four parts and contains the usual SAVE facility. There is also a HELP option which can provide details of the characters Adrian mentions. Thankfully, there is a Pictures On/Off facility - the graphics add nothing to the game whatsoever!

The Growing Pains of Adrian Mole follows the same format as Level 9's other spin-off, The Archers. These kinds of games are all right in their own way, but play them a few times and they become tedious. Still, people who really like Sue Townsend's books should enjoy it.

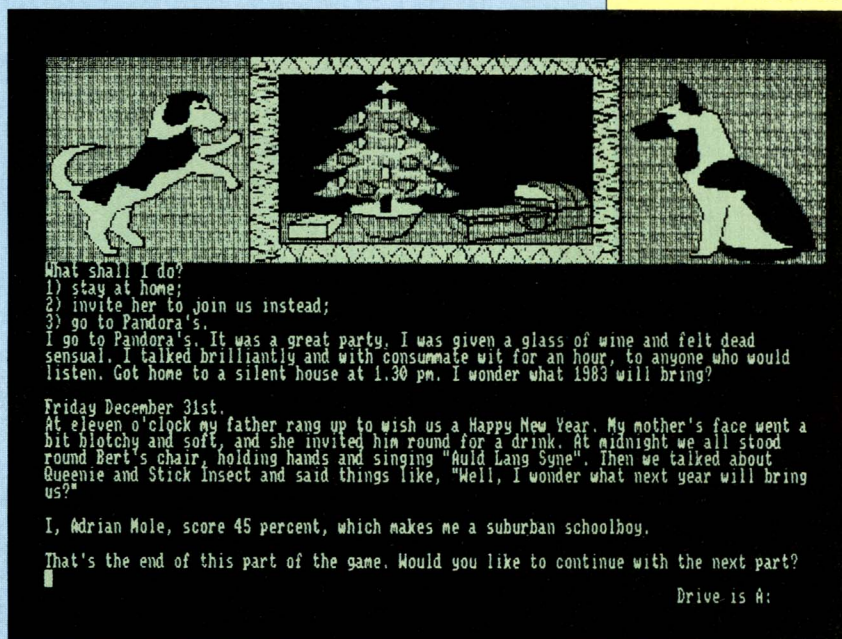

**PLUSES**

- Humorous, well-written text
- User-friendly
- Faithful to the original

**MINUSES**

- Graphics superfluous
- Not very testing
- Minimal input

**GRAPHICS ADDICTIVENESS** ■■■□□ ■■■□□

**LASTING APPEAL VALUE VERDICT** ■■■□□ ■■■□□

**CLASSIC COLLECTION**

£14.95 • Tynesoft • 091-414 4611

This compilation disk contains three 'classic' games - Hoppit!, Munch It! and Shoot It!. Essentially these are cheap and cheerful versions of the old faithful arcade games Frogger, Pacman and Space Invaders. What more needs to be said? As such titles suggest, these games are not the most demanding ones around, and certainly not the most stimulating!

Hoppit gives sadistic motorists a chance to make up for their evil deeds. Instead of squelching all those little innocent beasties under your burning wheels, your task is to guide little green froggie (hence the startlingly original title) firstly across a busy motorway and then over a fast flowing river.

Having dodged his way through cars and trucks, froggie must leap onto the turtles and logs which float in the river. These are, in effect, his stepping stones to the other side and home.

Once you've guided five froggies across the road then you move on to the next screen. Each screen is progressively faster and you have to look out for crocodiles who are rather partial to frog sandwich! Fortunately froggie has five lives.

Munch-It takes (you've guessed it) eating as its theme. The screen presents you with a maze filled with dots.

Your task is to guide a munching orifice through the maze, gobbling up as many dots as you can.

However, it's not quite as simple as that. There are a number of ghosts inhabiting the maze as well. As they haven't had a square meal in centuries, it's understandable that they should want to eat you all up!

I feel sure that behind the facade of this rather inane game lurks a profound allegory on the nature of private enterprise and the market economy. So be warned!

Shoot-It is, believe it or not, all about shooting. You have to zap as many aliens as you can, which is a shame really as they have such nice faces. Indeed, they seemed such a friendly bunch I didn't really have the heart to kill them.

The graphics are not really fast enough to be exciting. I fell asleep at least once during the action only to find myself still alive. Luckily, the screens become progressively less simple so that on one of the later screens I stayed awake almost all the time.

If you have young children then these three games might be worth buying. Otherwise, forget it!



**PLUSES**

- Playable
- Keys are responsive
- Can load without booting CP/M first

**MINUSES**

- Slow, plodding and predictable
- Repetitive

**GRAPHICS ADDICTIVENESS** ■■■□□ ■■■□□

**LASTING APPEAL VALUE VERDICT** ■■■□□ ■■■□□



# LOOPING THE LOOP

In part 5 of his BASIC tutorial, John Hughes explains how to go round in circles

**W**hat computers are particularly good at is repeating the same operation hundreds, or even millions, of times. This is particularly handy because mindless repetition of this sort is just the kind of thing which most of us humans find mind-bogglingly boring.

If required to work out the VAT on the tenthousandth item in one morning, humans are likely either to start making silly mistakes or to quit completely and have another cup of coffee. The computer, knowing nothing of coffee except as something that gets spilled over it, plods on as accurately as ever, and never gets bored or fed up.

Doing something over and over again is called 'iteration', and computers use iterations for all sorts of operations. A very common way in which they calculate square roots, for example, involves making an educated guess at the right answer, squaring that answer and comparing it to the original number, and then modifying the first guess and repeating the whole process.

Getting the correct answer hardly ever takes more than four or five tries, and you can see how fast it is if you load BASIC and then type in `PRINT SQR(50)`, or any other number you like. Incidentally, you now have a new BASIC keyword: `SQR` will find the square root of any number which is enclosed in the brackets immediately following.

```
10 REM Program to input numbers and find their total
20 REM Input is terminated by a zero input
30 REM 8000 Plus
40 CLS$=CHR$(27)+"E"+CHR$(27)+"H"
50 PRINT CLS$
60 RTOT=0
70 PRINT "Input a number please, or zero to terminate";
80 INPUT NUMBER
90 RTOT=RTOT+NUMBER
100 IF NUMBER<>0 THEN GOTO 70
110 PRINT
120 PRINT
130 PRINT "The total of all the numbers is";
140 PRINT RTOT
150 END
```

The program from Part 3

## Some rules about loops

**FOR-NEXT** loops aren't difficult to use once you see how they work, but there are a couple of points to watch.

▶ Never try to modify the counter variable in the middle of a loop. That is, if your counter variable is `LOOP%`, don't have a line reading `LOOP%=LOOP%+1` or similar inside the loop.

▶ Don't ever rely on using the value of a counter variable *after* you have left the loop, because different versions of

**BASIC** treat it in different ways. This unpredictability makes it a dangerous variable to use.

▶ Although you *can* leave a **FOR-NEXT** loop in the middle, provided that you return later to the point at which you left it, it is much safer not to jump out of a loop in the middle.

If you absolutely have to do one or more of these things in the course of a program, then use **IF-GOTO** rather than **FOR-NEXT** loops.

### Looping in BASIC

We have already made up programs which use the **IF** and **GOTO** commands to make 'unstructured' loops, and the running total program which we first met in the third part of this series, which used these commands, is reprinted here. To refresh your memory about this program, it asks you to input a series of numbers and adds them into a running total. When you type in the 'rogue value' zero, the program leaves the loop and prints the running total.

A loop of this sort makes sense when you don't have any idea how many times it is to be repeated – you can get out at any point by just pressing a zero. However, Locomotive BASIC does have two more formal loop structures which are a lot easier to follow than the **IF-GOTO** example, and which should be used in preference to **IF-GOTO** whenever this is possible.

The first of these is a **WHILE-WEND** structure (**WEND** stands for **END** of the **While** loop). A second and more useful structure is really the subject of this article; it is called a **FOR-NEXT** loop.

### I'm only here FOR the NEXT beer

The structure of the **FOR-NEXT** loop is shown in the box. You can see that it consists of two separate parts, one of which – the **FOR** part – comes at the beginning of the loop and the other of which – the **NEXT** part – comes at the end.

The **FOR** line consists of four parts, of which three are compulsory and one optional. Here is an example:

```
FOR LOOP%=1 TO 19 STEP 2
```

The compulsory items are the keyword **FOR**; the loop counter variable which we have called `LOOP%`, but which can have any BASIC variable name; the value which the counter variable is given when the loop is entered for the first time; and the value which the counter variable must reach to make it end the loop.

The optional item is **STEP**, which tells BASIC by how much the counter variable is to be increased every time it goes through the loop. If you leave it out, BASIC assumes you meant **STEP 1**.

The **NEXT** line consists of the keyword **NEXT** and the name of the loop counter variable, eg.

```
NEXT LOOP%
```

31597 free bytes

```
Ok
10 FOR LOOP%=1 TO 5 STEP 1
20 PRINT LOOP%
30 NEXT LOOP%
40 END
RUN
1
2
3
4
5
Ok
```

Program 1



## A working example

This is rather a lot to take in at one go, so type in Program 1 and RUN it. You should get the result shown. What has happened is that on the first trip through the loop, the counter variable LOOP% is set equal to 1 (by the LOOP%=1 command) so that the value 1 is output by the PRINT statement in Line 20.

When the program reaches NEXT in Line 30, LOOP% is increased by the value stipulated by STEP, so that on the second trip through the loop the value which is output is 2; this continues until LOOP% is equal to 5, which has been chosen as the ending value for the loop, at which point control of the program 'falls through the bottom' of the loop and the program ends.

Try altering some of the parameters in Line 10 to see what happens when you run the program; you can try different values for both the starting and ending values of the loop as well as for STEP, provided that you choose whole numbers (because LOOP% is an integer variable) and that the starting value is lower than the ending value.

```
10 FOR LOOP=0.1 TO 1 STEP 0.1
20 PRINT LOOP
30 NEXT LOOP
40 END
```

Program 2

## What's wrong with real numbers?

In the last article, we warned that some fractional values can't be held precisely in the computer. To see this, try Program 2. This is just a variation on Program 1 using real numbers instead of integers. The calculation works fine up a certain point, but then the rounding errors take control.

One odd result of this is that, although 1 is given as the ending value of the loop, it never actually gets printed. The moral of this is that loops which rely on a real number for the loop counter are not to be trusted!

```
10 FOR LOOP%=5 TO 1 STEP -1
20 PRINT LOOP%
30 NEXT LOOP%
40 END
```

Program 3

## 10, 9, 8, 7, 6, 5 ...

You can use a FOR-NEXT loop to count down as well as up; Program 3 is a simple variation of the first program to show how this is done. The ending value is smaller than the starting value, and the STEP value is a negative one.

In Program 4, we make sensible use of a FOR-NEXT loop to get away from the awkward IF-GOTO structure of the running total program we started with. This version doesn't just work out the total, but works out the average as well.

There are a couple of things to notice about the program. The first is that you can use variables instead of numbers for the start and end values of the loop; it is possible to use a variable for the STEP value as well, but that doesn't happen so often. In this program, we have to ask for the value in Lines 60 and 70 before we can use it to control the loop.

Second, we have used the shortest possible form of the FOR-NEXT command; we have done without the keyword STEP, which is unnecessary because the loop is going up in steps of 1 anyway; and we have also left out the name of the loop counter variable in Line 90 after the keyword NEXT.

## More than one loop at a time

If you want, you can put one FOR-NEXT loop inside another. Program 5 is a simple example of this kind of thing, and if you type it in and run it you will see how the

```
10 REM New program to input numbers and find their total and average
20 REM 8000 Plus
30 CLS$:CHR$(27)+"E"+CHR$(27)+"H"
40 PRINT CLS$
50 RTOT=0
60 PRINT "How many numbers?"
70 INPUT CASES%
80 FOR LOOP%=1 TO CASES%
90 PRINT "Type in a number"
100 INPUT NUMBER
110 RTOT=RTOT+NUMBER
120 NEXT LOOP%
130 PRINT "The total of all the numbers is";
140 PRINT RTOT
150 AVERAGE=RTOT/CASES%
160 PRINT "The average is";
170 PRINT AVERAGE
180 END
```

Program 4

```
10 FOR LOOP1%= 1 TO 5
20 PRINT LOOP1%
30 FOR LOOP2%=1 TO 5
40 PRINT LOOP2%
50 NEXT LOOP2%
60 NEXT LOOP1%
70 END
```

Program 5

two loops are 'nested' one inside the other. This is the best way to see how it works, as it can get confusing otherwise.

The output from this program will begin as follows:

```
1 (that's LOOP1%, first time round)
1 (LOOP2%, first time round)
2 (LOOP2%, second time)
3 (LOOP2%, third time)
4 (LOOP2%, fourth time)
5 (LOOP2%, fifth time)
2 (back to LOOP1%, second time round)
1 (LOOP2% starting over again)
```

and so on.

Each loop is treated as a separate entity, and the inside one is taken back to the beginning every time it is entered.

Look at this example very carefully; even experienced programmers can get themselves tied into knots when they are working out where they are in nested loops, as I know only too well.

```
1 REM This program is illegal!
10 FOR LOOP1%= 1 TO 5
20 PRINT LOOP1%
30 FOR LOOP2%=1 TO 5
40 PRINT LOOP2%
50 NEXT LOOP1%
60 NEXT LOOP2%
70 END
```

Program 6

The only additional rule that you have to follow with nested loops is that they must be fully nested inside each other. Program 6 is illegal, because the NEXT for the inside loop comes after the NEXT for the outside loop. **EXIT**

## Things that go wrong in loops

Mostly, FOR-NEXT loops don't cause too many problems; this is because they have a clear structure, so that you can see exactly what you are doing much more easily than with the IF-GOTO combination. However, there are a couple of things which can go wrong.

If a loop is only executed once when you believe it ought to be executed several times, check that the starting and ending values are right, and that any value for STEP makes sense too.

This is especially important if you are using variables to establish these values, as it is very easy to change the value of a variable without realising it.

If the opposite happens, and the program doesn't come out of a loop at all, check the same points.

An 'Unexpected NEXT' error message almost always means that you have not got your loops properly nested; alternatively, you may have put the wrong name for the counter in the NEXT line.



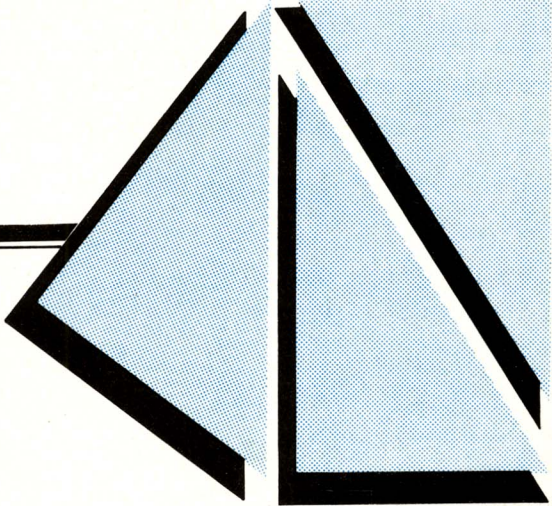

# Your Dreams Come True...

## TELEADD

The electronic telephone & address book for home or business use.

PCW £21.95

## INSTOCK

The only true stock control & order processing program on the PCW.

Its main frame computing on a micro  
(As used for the M.O.D.)

PCW £59.95

## INTACT

An amazing accounts package with nominal sales & purchase ledgers etc.  
Can stand alone or be integrated with INSTOCK.

PCW £59.95

## INSTALL

INSTOCK & INTACT already to Load & Run on your computer with a saving.

PCW £99.95

## CONTRACT

Contract Accounting now available.  
Works with Intact or Install. Totally unique to the PCW.  
Most useful for Builders, Solicitors, etc.

PCW £59.95

*"Jo Stork reviews an accounting system and is greatly impressed"*  
BUSINESS COMPUTING WITH THE AMSTRAD  
FEBRUARY 1987

Also now available Simple Invoicing.

# CAVALIER SOFTWARE

AVAILABLE MAIL ORDER FROM:

LOAD & RUN  
P.O. BOX 123 DEPT 80004  
DARTFORD DA1 5AA OR

RING 0322 72116/73128 FOR CREDIT CARD ORDERING  
OR TRY YOUR LOCAL DEALER.

E. & O. E.



## SERIOUS WRITERS ONLY!

If you are writing a **book, thesis, scientific treatise, report**, or any other text that requires an accurate index, our program **AnsibleIndex** is what you need. It is the *only* indexing software available for LocoScript.

Here are the main features:

- Up to **1,500** different entries
- Automatic **alphabetization**
- Exact **page numbers**
- Lists **words, phrases** and **inverted phrases**
- No special commands to learn...if you use LocoScript, you can compile an index
- Full **page proof compatibility**: optional dummy format, plus reorganization to match printed book
- **AnsibleCheck** included - see below
- Price: **£49.50** (incl. VAT & carriage)

We also supply the only trouble-free LocoScript word counter, **AnsibleCheck**:

- Counts words as *words* (no estimates)
- Simple to use...one command runs the program, automatically
- Works with ordinary LocoScript files...no special preparation
- Also seeks (and shows in context) any words that have been repeated
- PRICE: **£19.50** (incl. VAT & carriage)

Both packages include a special "extra": the dreaded **GREASE**, scourge of writers everywhere.... A comprehensive manual in plain language (author: 8000 PLUS columnist David Langford!) is included with both packages.

Ask for our brochure, or order direct, payment enclosed:

## ANSIBLE INFORMATION

(Dept. 8002) • 94 London Road • Reading •  
Berkshire • RG1 5AU  
Tel: 0672 62576



## NEW FEATURES ON CHIBASE

- Insert mode editing option
- 'Tabbing' around forms: the cursor can be quickly moved from one heading to another
- Cursor movement by word and to end of line
- Single key database commands
- Editor commands set to word processor keys as well as the original Alt keys
- Improved manual with index

### CHIBASE From CHIASMA SOFTWARE SYSTEMS

CHIBASE is a text retrieval system for the amstrad PCW8256/8512 computer  
CHIBASE is a **NEW** and **EASY** way to store and recall text on disc, works like a notebook

CHIBASE has all the features needed to store and recall **HUNDREDS** of text records on your PCW8256/8512 computer

CHIBASE is used by **RESEARCHERS INDUSTRIALISTS STUDENTS TEACHERS** and others

### CHIBASE features:

- Fast and easy to use: no complicated syntax to learn
- No tiresome setting up of record formats (though you can set up a form to help you enter text)
- Single key, mostly mnemonic, database commands
- Free format text up to 23 lines of 80 characters
- On-Screen highlighting to indicate 'key' words
- Word processor compatible

The manual includes a tutorial introduction and full explanation of all commands

Price **£49.95 inc.** (Existing users send **£4.00** plus original disc)

### CWMBRAN COMPUTER CENTRE

3-4 Ventnor Road., Old Cwmbrian, Gwent  
Phone (06333) 60996 or (0222) 567048

Access/Visa welcome

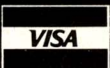

If you're in the area, why not drop in for a free demonstration?  
open Mon-Thur 1.30-8.00 Sun 10.00-1.00







As an author, I always get depressed when some bore gets me in a corner and moans about the price of books. The bore may own a VCR and 200 tapes, a super hi-fi system plus 1000 costly LPs and compact discs, and a games computer with endless cassettes costing £5-£15 apiece... but he or she is adamant that a £10 hardback is Too Expensive. I even know people who've started small publishing outfits, confident of being able to clean up by undercutting the evil book barons. After exposure to the horrible facts of economics, these little companies either vanish rapidly or find themselves charging even more than the publishers they distrusted...

As part of a tiny software house, I get the same depression from countless magazine editorials about wicked software overpricing. (Er, *8000 Plus* is exempted from what follows, of course, of course.) Obviously it would be nice if no software cost more than £5. But I do gag a bit on reading an editorial saying that £20 for software is a scandal on the order of Sodom and Gomorrah... when simultaneously the advertising department writes to announce that a teensy quarter-page in which to tell people about said software will cost £200. (Or £300, depending on the magazine's pretensions.)

How does that bloated, capitalistic £20 break down? The first dent comes from VAT, which must be joyfully passed on to HM Customs and Excise. Mumble mumble, count on fingers, three twenty-thirds of £20, that's £2.61. Still in the kitty: £17.39.

Next, software has to be put on a disk. (This may sound obvious, but I've met customers who hadn't twigged that the disk had to go in the drive.) CF2 disks are no longer

# LANGFORD'S PRINTOUT

A page foolishly handed over to SF author DAVID LANGFORD who just happens to own an AMSTRAD



## IT'S A HARD LIFE FOR IMPOVERISHED WRITERS

sought-after rarities, thank goodness, but there isn't such a glut as to allow massive discounting as with 5 1/4" floppies – which can be had in bulk for 40p each! Our little outfit could do better by buying thousands rather than hundreds, but right now the CF2s cost us £2.30 apiece. The kitty stands at £15.09.

A manual is essential, and people will be justifiably unhappy if this consists of a scrappy page of cryptic illiteracy. (Often the case. I have this theory that the Federation Against Software Theft encourages unreadable manuals, to deter bootlegging.) There are plenty of decisions here... The more manuals you print, the bigger the investment, the lower the unit

cost, and the longer before you can revise the thing to cover software improvements. Cheap ring-binders may require more postage than pricier paperback-style binding. I reckon a decent manual will cost at least £2 to produce. In the kitty: £13.09.

Postage and packing, that boring pair, come to around 80p despite frantic cost-cutting: envelope, address label, sellotape, internal folder(s) to protect the manual and disk, and those hideously overpriced bits of paper sold by the Post Office. I still haven't worked out the innovative fifth-generation technology which makes the perforations so much stronger than the stamps. The kitty: £12.29.

(Thanks to this emphasis on mail-order, you're spared the pity and terror of discounting: dealers expect to cream off 35% to 50% of the gross, so feel free to recalculate my sums with a reduced initial kitty of £13 or £10.)

Calculating publicity costs is where this starts to get difficult. No publicity means no sales. Massive mega-publicity in all 5,271,009 Amstrad magazines means swift bankruptcy before you get any response... Let's take a modest advertising budget of £400 a month (i.e. quarter-pages in a couple of magazines). These ads mostly produce requests for persuasive, lavishly produced brochures. An empirical statistic – meaning I just looked it up in the records – is that you get about one order for each four brochures sent

out. A good brochure, with postage, costs around 55p. The effective kitty, if you think about it, just went down to £10.09.

So here's our happy software firm, raking in a totally unjustifiable £10.09 per order – after the first 40 sales each month, which merely pay for the ads. There are still hidden costs, too. Credit card orders lose a percentage to Access (4%) or Visa (5%); there are capital investments like computers, copiers, answering machines and manual-binding apparatus; the phone bill is hideously swollen by business calls; the bank's promise of "no charges if you stay in credit" doesn't apply to a business account; and so on, forever.

The hardest thing to assess is time. Developing, maintaining and copying software; writing, rewriting and producing manuals; stuffing disks in envelopes; writing up the books and tax and VAT; answering endless written and telephoned queries... bit by bit it tots up to a 27-hour day. Most customers are friendly, kind and patient people, I hasten to add. Unfortunately a few belligerent or thick callers can spoil others' support by leaving the guy who answers the telephone ragged and exhausted...

Ultimately, for my own two-man operation, the question of pricing boils down to: what should a small software house charge for a task which somehow overflows into every second of free time? One of our very big suppliers once justified its outrageous carriage charges by telling us the salary earned by the unskilled employees who stuffed boxes into jiffybags. It was a damn sight more than either partner in Ansible Information was taking home.

This column has been a momentary aberration. Bear with me.

EXIT

### How To Madden A Software House: Eight Tried and Tested Ways

- 1) Ring before 9am with a complex technical query.
- 2) When ordering by credit card, always use Visa (the software house gets less profit).
- 3) Ring during *Hill Street Blues* (small outfits work from private homes, har har).
- 4) Never open the manual. Ring and complain first.
- 5) When you write, avoid quoting names, dates or reference numbers. "Some time ago I bought some of your software" will really make them

- hunt through the files!
- 6) Ring at lunchtime to demand support for the program which a pirate pal copied to you for nothing.
- 7) Get very abusive when the software house can't advise you about a program written by somebody else altogether.
- 8) Cultivate an air of injured innocence as you complain, "It doesn't say anywhere in the manual that you have to switch the computer on...."



# TWIN DISK SIMULATION!

FEATURING...

  
**Heathrow**  
AIR TRAFFIC CONTROL

AND...

**SOUTHERN BELLE**

TAKE THE FOOTPLATE  
OF THIS FAMOUS STEAM  
LOCOMOTIVE!

2 EXCITING TRAVEL SIMULATIONS  
FROM PAST & PRESENT!

**HEWSON**

Hewson Consultants Ltd.  
56b Milton Trading Estate, Milton,  
Abingdon, Oxon. OX14 4RX.

**AMSTRAD**  
PCW 8256 & 8512  
£16.95







If your Amstrad came with a Government Health Warning stating that it can seriously damage your health, you'd be worried. It doesn't, but it's all too easy to rush into using a personal computer completely ignoring the most vital component – the user.

You may not know it, but as soon as you sit down in front of your monitor your familiar desk is transformed into a 'work-station'. Continuing to use an inappropriate desk or chair can mean you are working in a way that is bad for your health.

People come in various shapes and sizes, and the components of the work-station need to be adapted to suit. Make sure you have enough space to move about.

The Health and Safety Executive has put forward a general checklist for workplace design:

- 1 If working at a VDU for long periods you need a chair with adjustable height and back support.
- 2 There is no such thing as an 'ideal posture' but the sitting position shown in the diagram will help reduce tiredness and reduce the possibility of muscle stress.
- 3 No matter how well your chair and desk are designed, don't sit in the same position for too long. You should change your posture as often as possible.
- 4 Make use of detached keyboards by positioning them to adjust your system to meet your needs.
- 5 Some movement is desirable, but not repeated stretching. Have everything within easy reach.
- 6 Don't rest wrists on the edge of the keyboard or desk. Don't bend your hands up at the wrist. Try to keep a soft touch on the keyboard and don't overstretch the fingers – good keyboard technique is important.
- 7 Try different arrangements of keyboard, screen and document holder to find what works best.
- 8 Avoid bright lights being reflected in the screen and don't look directly at windows or bright lights. Close the curtains to cut out any unwanted light.

### The eyes don't have it

Many people may not even realise they have defective eyesight until they start using a VDU. Then they can get eye-strain, irritation and itching, temporary blurring of vision or headaches.

Everyone is entitled to a free National Health Service eye test every year. If you are having problems, make an appointment with your optician and tell him whether you use a monitor for reference (a few minutes at a time), occasional use (between 15 minutes and two hours), regular use (more than two hours at a time) or continuously.

Sogat '82, the printing trade union, found that complaints of eye strain and blurred vision were worst in operators needing glasses or who had glasses that were incorrect for VDU work.

A more unexpected complaint from some VDU users is itching skin or a redness of the face and neck. So far, research has put this down to a combination of a dry atmosphere and static electricity near a VDU. If you suffer from this it might be worth working on an anti-static floor covering, using a screen shield to cut down screen glare and making sure the humidity doesn't fall too low.

The U.S. National Institute for Occupational Health and Safety, and our own TUC, recommends 15 minute break after two hours although this should be a break after only one hour where there are "high visual demands, high work load or repetitive work."

Using a PCW is not, of course, a particularly risky activity. The only important thing is that we give proper consideration to the most vital component – the user. **EXT**

# Computers can damage your health

Tom Hingley explains the black art of ergonomics – or how to let your PCW live in harmony with your eyes, neck, back, wrists ...

If you really catch the computer bug you can end up only taking time for sleeping, eating, reading 8000 Plus and working at your PCW. At that point you may well discover that it is possible for computeritis to be as damaging to your health as any of the other bugs going around.

## Meeting eye to VDU

Many computers, like IBM PC clones, have their VDU screens on top of a bulky main box. This puts the screen at eye level, which is a good thing. Unfortunately, the design of the PCW does not allow this.

You can buy specially designed combination desks with adjustable height and angles for the monitor, keyboard and printer. There are also desk consoles and desk printer stands which place the monitor at eye level

and have the keyboard angled towards you.

For those of you who squander all your money on software, an ingenious solution is to collect all those mail order catalogues you are inundated with and put them under the PCW monitor to get it to the right level. A thin ledge of picture framing under the top edge of the keyboard helps to tilt it to a nice angle.

▼ An impressive looking diagram showing the recommended optimum position for computer work. The user's unnatural thinness is probably caused by waiting for LocoScript to finish scrolling through a 200 page novel.

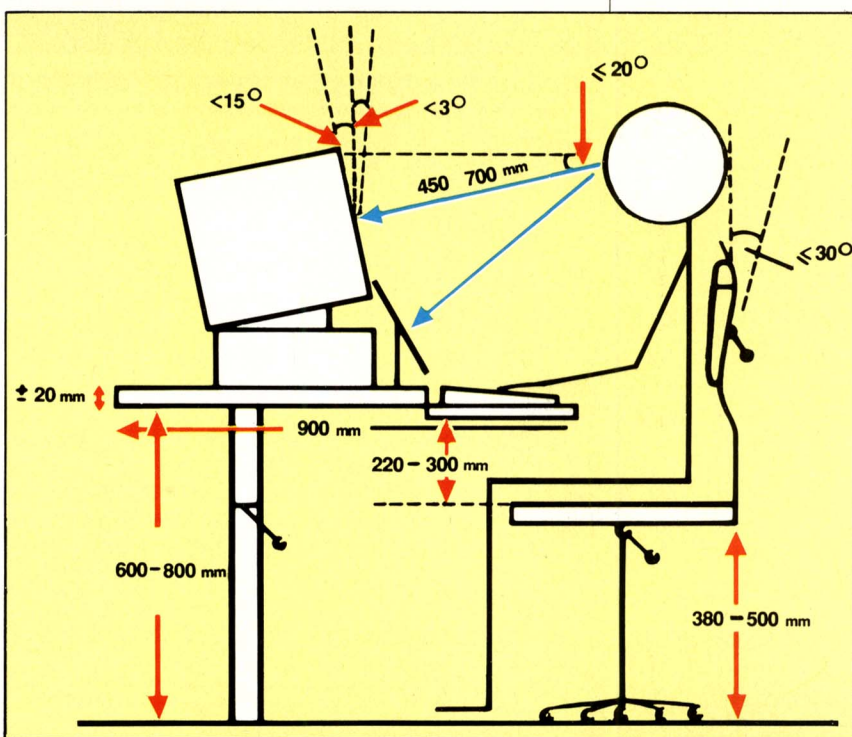



### THE TIME OF THE SIGNS

#### SIGNWRITER

£49.95 • Wight Scientific • 01 858 2699

Do you have something so important to say you feel it should be written in letters 100 feet high? Well Wight Scientific's Signwriter can't quite do that but it can certainly do enough to impress the average PCW user.

Signwriter is a program which can take any string of text you like and print it out as a large banner on the PCW printer. It can print either across the page or down the page, so lengthy text can run down several pages of continuous stationery. The text can be boxed and underlined.

**QUIET**  
**Genius at work**  
But it's not me

**Why can't I think of anything important to say in this sign**

▲ A sample of Signwriter's output

At nearly £50 most people who would think of buying this program will probably have a serious application, although it is still fun to play with. The company have made an effort to reach a happy balance between flexibility and being idiot proof. The result is a package that you can be using successfully quite quickly but still seems to have an almost infinite potential for adapting and creating your own characters and fonts.

The standard font that characters come out in is a crisp, bold typeface without serifs. The quality is surprisingly good, and looks nothing at all like dot matrix printout – see the sample shown. There are a variety of other fonts available, for £5 extra, some of which have actually been designed by Signwriter users. These include Rome (a Roman type font) and Hand (a romantic, flowery one).

But don't be tempted to rush at this program. Even if you get your sign set up quickly it does take a minute or two to print, while the printer does its three passes. The plus side of this is good quality print that looks almost too good to have been produced on a PCW printer.

Wight intend making improvements which they think could double the speed and the capacity of the program and they offer an updating service (around £5 for a new version) and they will provide new fonts as they are developed, for around £5 (plus the cost of a disk).

This program is aimed at the big stuff – notices, signs, anything that needs to be read from a distance. Problems can arise if you want to get the letters less than about 8 millimetres. Wight are working on a program to cater for the smaller printing which is about two or three months away.

At the other end of the scale the only limit seems to be the size of the paper. For normal purposes the program seems capable of taking many decisions for you (such as spacing etc) unless you particularly want to do

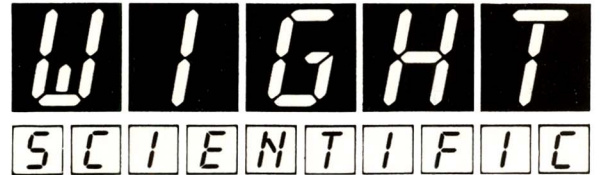

your own thing. You choose the height of your letters and are then informed what length your line will be and more important whether you are going to run off the end of your paper. At this point you can underline, put a box round your sign and even mess about with the spacing between letters.

If you're setting up window displays or exhibitions, Signwriter could be just the thing for you.

RANGE OF FEATURES  
EASE OF USE



PERFORMANCE  
DOCUMENTATION



8000 PLUS VALUE VERDICT

### DAISY, DAISY ...

#### LSPRINT

£19.95 • Bradway Software • 0742 350225

What do you mean you're not completely happy with the speed and quality of print of your PCW printer? What do you mean you want to use LocoScript but with a daisy wheel printer? Some people are never happy.

Help is on the way from Bradway Software in the form of a program called LsPrint, a utility to print out LocoScript files on a daisywheel printer. First the disappointment: it doesn't work direct from LocoScript but from CP/M instead. This means you have to complete all your documents, save them, load up CP/M and then run the program.

This may seem rather tortuous although it is a great improvement on having to turn your documents into ASCII files and losing all your fancy format commands in the process. LsPrint does simulate virtually everything (or at least a reasonable version of everything) that LocoScript can do.

For instance underlining, emboldening and pitch changes are no problem. Subscript and Superscript it gets round by printing above or below the line although since daisywheels can't change the size of their text this can interfere with other lines of print.

It is easy enough to use taking you through a menu system similar to LocoScript. It asks what disc your file is on and then shows you a directory of files for you to choose. Then it asks a few simple questions (like what pages you want printed) and away it goes.

One annoying feature is that it returns you to CP/M as soon as this document is completed. Most people would probably have more than one file to print and especially on the 8256 where you have to swap discs; reloading the program would perhaps become tiresome. Still at £19.95 it is by no means expensive and certainly cuts out most of the major problems.

RANGE OF FEATURES  
EASE OF USE



PERFORMANCE  
DOCUMENTATION



8000 PLUS VALUE VERDICT



# DATABASE MANAGER (AT LAST)

for CPC 6128, PCW 8256, PCW 8512

Ben Taylor 8000 PLUS (Jan 1987)

"AT LAST is Superb Value for money and hard to pick holes in. It can do all of the operations you need for general use..."

## AT LAST THE FACTS

For those who know what the figures mean, here is what AtLast can offer to your filing system:

- ▶ Menu operation – usually a single keystroke for a single function
- ▶ A record may contain up to 20 fields, BUT each field may have up to 99 elements. For example, you could store a 5 line address in a single field with 5 elements.
- ▶ A field (or element) may be up to one line long (79 characters)
- ▶ You can have multiple indexes to a database – e.g. you can sort it by both surname and date of birth.
- ▶ You can select records or groups of records by quite complex conditions,

e.g. 'All people who owe more than £100 and live in Reading'.

- ▶ The format of screen layouts and printed output is fully definable. You can print labels, lists, simple mailshots in almost any form you like.
- ▶ Records can be read or written to ASCII files.
- ▶ You can make some changes to the record format even after the data has been entered
- ▶ For numeric fields, you can print their total at the end of a listing (although there is no general arithmetic allowed in fields)
- ▶ You get 60 days free support thrown in.

RANGE OF FEATURES  
EASE OF USE



PERFORMANCE  
DOCUMENTATION



8000 PLUS VALUE VERDICT

ONLY £29.95 inc VAT

Available from selected branches of WH Smiths and all good retailers



Trade enquiries: 0279 412441

Software Promotions Ltd, 17 Staple Tye, Harlow, Essex CM18 7LX

# DIGITA INTERNATIONAL

NEW

PLAN  
YOUR OWN  
TAX WITH

## PERSONAL TAX PLANNER

£24.95  
Inc. VAT and P&P

Make sure your taxman is doing his job correctly with Digita's Personal Tax Planner. Fully menu-driven, "PTP" is a U.K. income tax computation program which will calculate your income tax liability for a given tax year and provide pertinent facts about your tax position. Information, once entered, can be easily saved and amended and this can be used to provide useful "what if" calculations on your tax liability. For example, you could use PTP to see what effect an increase or change in allowances has on your tax liability.

Guidance notes are provided for users unfamiliar with the operation of the U.K. tax system. Nothing could be more simple! **NOTE: Software update service available for changes in legislation.**

"...very easy to follow and the calculations are accurate. If you need a ready-made program of this kind, it will certainly do the job."  
Amstrad Personal User, January 1987.

UP  
GRADE  
YOUR  
PRINTER

## Supertype

£19.95  
Inc. VAT and P&P

Previously published as FONTGEM

Supertype will give you 8 radically different type faces, and will work directly with any of your software including Locoscript. NOW LOCOMAIL / LOCOSPELL COMPATIBLE.

"The program is menu driven and very easy to use. For the business user who just wants a different print style, possibly changing it occasionally, then FontGem (Supertype) is easily the best."

Popular Computing Weekly, 11th - 17th December 1986.

SUPERNOVA SOFTWARE PRESENTS

## CLASSIC INVADERS

"Ideal therapy after a frustrating day using the PCW."

The Complete Guide to the Amstrad.

£12.95  
Inc. VAT and P&P

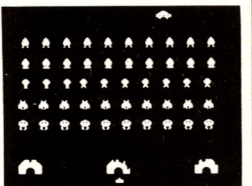

## DATASTORE - the professional database.

£39.95  
Inc. VAT and P&P

Looking for fast access to stored data? Want to create customised reports, mailing labels, office and personal records with NO technical knowledge....? Researched, developed and written exclusively for the Amstrad PCW, Datastore will fully utilise the facilities of your computer. It makes an ideal partner for the novice or expert.

Some of the many features include:

- Menu-driven with prompts.
- Numeric, string, date and money fields.
- Full mathematics, + - x ÷ and average.
- Up to 4 user-definable keys (40 characters) for each file.
- 32,000 records, more with hard disc.
- 32 fields, 8 key fields.
- Lightning search feature - typically under 4 seconds.
- 1,498 characters per field.
- Uses M drive and A or B drives.
- 1 or 2 drives open at one time - allowing cross referencing between files.
- Fully supported printer options.
- 2 user-definable printing templates.
- Search on any field or combination of fields for any information.
- Optional conditional search facility.

- Uses full width of PCW screen.
- Facility to completely change the record layout after you have entered your data.
- Automatic calculations on entry particularly useful for VAT, etc.

Can be used for:

- Mailing Lists
- Personnel Records
- School Reports
- Plant Records
- Order Forms
- Statistics
- Membership Records
- Customer Records
- Telephone Directory
- Job Cards
- Catalogues
- Stock Control

INCLUDES  
FULL TUTORIAL  
FOR BEGINNERS

Previously published as DATA GEM

ORDER NOW ☎ (03954) 5059



Please send me.....

I wish to pay by Cheque / P.O. / Access / Barclaycard. I authorize you to debit my Access / Barclaycard with the amount £.....

Card No. ....

Name: .....

Address: .....

Signature: .....

Send to: DIGITA INTERNATIONAL Ltd., Kelsey House, Barns Road, Budleigh Salterton, Devon, EX9 6HJ.



# MASTERFILE 8000

FOR ALL AMSTRAD PCW COMPUTERS

MASTERFILE 8000, the subject of so many enquiries, is now available.

MASTERFILE 8000 is a totally new database product. While drawing on the best features of the CPC versions, it has been designed specifically for the PCW range. The resulting combination of control and power is a delight to use.

Other products offer a choice between fast but limited-capacity RAM files, and large-capacity but cumbersome fixed-length, direct-access disc files. MASTERFILE 8000 and the PCW RAM disc combine to offer high capacity with fast access to variable-length data. File capacity is limited only by the size of your RAM disc.

A MASTERFILE hallmark is the provision of multiple, user-designed display formats. This flexibility remains, but now it's even easier. With MASTERFILE 8000 you design your formats "live"; no more questionnaires, just move your format effects around the screen using the cursor keys!

Record updating is even easier than before — just steer your cursor to any field on the screen and then insert/erase/alter as required.

Special options are provided for handling dates and surnames, and column totals can be generated.

All screen work is done graphically — and hence we offer unique panel, box, and ruled line options. Choose the line spacing at pixel resolution — you will be amazed how much clearer 9-pixel lines are than the usual 8-pixels. (Study the picture.) And all this faster than CP/M normally lets you paint the screen! PCW printer functions, under menu control, are provided.

Customer Details and Invoices				
British United Freight 493 Western Avenue Gloucester GL9 5JN		Tel: 0452 654321 Contact: Mike McManic Ref: BUF		
Invoice	Tax point	Amount	Date paid	Comments
12044	20 Aug 87	£235.00	02 Oct 87	
12399	29 Aug 87	£98.00	02 Oct 87	
12450	01 Oct 87	£305.00		re
12453	21 Oct 87	£133.00		
12533	03 Nov 87	£1,004.50		
12538	10 Nov 87	£355.65		
12783	11 Nov 87	£206.00		
12782	11 Nov 87	£39.20		
12839	04 Dec 87	£883.55	04 Dec 87	Cash with order
Totals:		£3,253.90		
Date of invoice				
Drive:A File:INVOICES Records:00017 Selected:00009 Key: Format:1				

Keyed files are maintained automatically in key sequence, with never any need to sort. You can have unkeyed files too, where records can be inserted at any point in the file.

Any file can make RELATIONAL references to up to EIGHT read-only keyed files, the linkage being effected purely by the use of matching file and data names.

You can import/merge ASCII files (e.g. from MASTERFILE III), or export any data (e.g. to a word-processor), and merge files. For keyed files this is a true merge, not just an append operation. By virtue of export and re-import you can make a copy of a file in another key sequence. New data fields can be added at any time.

File searches combine flexibility with speed. (MASTERFILE 8000 usually waits for you, not the other way around.) You can even assign subsets of a file into one or more of seven pigeon-holes for subsequent reference or further manipulation.

Megaglomerate Ltd				
Sales Contact: Martin McManic		Mega House 143-145 London Road Chelmsford Essex CM1E 5EG		
Telephone: 0245 654321		Reference: MGL		
Date of last order: 14 Aug 86		Value to date: £31,455.00		
Ref	Maker	Model	Specification	Price ex VAT
CS001	Epson	FX85	100cps 40MLA 80col	£310
CS002	Epson	FX105	150cps 40MLA 132col	£410
CS003	Epson	FX100	100cps 132col	£195
CS004	Epson	LX80	100cps 20MLA 80col	£435
CS005	Epson	LX80	100cps 40MLA 132col	£575
CS006	Epson	LX80	100cps 40MLA 80col	£275
CS007	Epson	FX800	300cps 40MLA 80col	£225
CS008	Canon	850	100cps 40MLA 132col	£370
CS009	Canon	850	100cps 40MLA 80col	£240
CS010	Canon	850	100cps 40MLA 80col Colour	£410
CS011	Juki	5510	150cps 40MLA 132col	£290
CS012	Juki	6100	30cps daisywheel	£350
CS013	Juki	6200	35cps daisywheel	£240
CS014	Juki	6300	220cps 50MLA 132col	£1,795
CS015	Fujitsu	DX	220cps 50MLA 132col	£2,700
CS016	Fujitsu	LBPSA1	8 page min M4 graphics	£1,990
CS017	Canon	LBPSA2	8 page min M4 graphics	£2,650
CS018	Canon	Laser	100cps 50MLA 80col	£285
CS019	HP	Laser		
CS020	HP	NP-810		
CS021	Taxan			
M - Help on off Drive:A File:MEGAGLO Records:00021 Selected:00021 In:Ref Format:1				

MASTERFILE 8000 is totally menu-driven, fully machine-coded, and comes with example files and a detailed manual. We claim (modestly) that you will not find another filing system with such power, flexibility, and friendliness.

MASTERFILE 8000 costs £49.95 including VAT and P&P to anywhere in Europe. Elsewhere please add 20% for air-mail service. ACCESS/VISA/MASTERCARD orders are welcome, written or telephoned, quoting card expiry date. Make cheques payable to "Campbell Systems".

Our normal response is return of post, 1st class.  
CAMPBELL SYSTEMS (Dept 8PL)  
7 Station Road, EPPING, Essex CM16 4HA,  
England. Tel: (0378) 77762/3



# Saxon Computing

**Flexi Collection** for PC 1512 & IBM

**Micro Collection** for PCW8256/8512

Each collection contains

- DATABASE
- WORD PROCESSOR with MAIL-MERGE
- LABELLING PROGRAM for goods or mail labels
- FILE ENCRYPTION software for data security

Plus a FREE SPREADSHEET program

## What The Magazines Say

*"Very good general purpose office control package"* 8000 Plus  
*"Database ... simple to use, fast and reasonably powerful"* Popular Computing Weekly

*"An impressive combination"* Computing With The Amstrad

*"Good value"* 8000 Plus Good Software Guide

**Flexi Collection or MicroCollection just £49.95 inc VAT & postage**

Call for details of our disk translation service  
 PCW disk data to PC1512 disks in 24 hours

SAXON COMPUTING

11 ARRAM ROAD

LECONFIELD

N. HUMBERSIDE

HU17 7NP

Telephone 0401-50697



# FOCUS

COMPUTER SYSTEMS (UK) LTD.

Introducing exciting **New** software for Amstrad PCW users . . .

## SMARTCARD

Simple to operate and so useful, SMARTCARD combines the ease of a card index system with advanced database features. Users of SMARTCARD can produce their own database record structures and the inclusion of sorted reports enable the selection of information from a number of records and the production of mailing labels.

Price **£59.95** inc. VAT



EASYPIP makes life easier for the non-technical user by allowing file transfer between disk and memory without learning the CPM PIP command sequences. Particularly attractive to single disk drive Amstrad 8256 users, EASYPIP avoids difficult, time consuming swapping of files and disks whilst needing the minimum number of keystrokes. Price **£19.95** inc. VAT

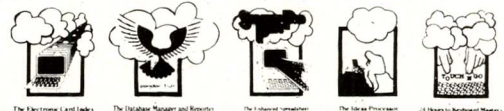

Focus are suppliers of a comprehensive range of **Canton** business and professional disk software.

**Post the coupon today and find out more about FOCUS software!**

Please send me information on SMARTCARD and EASYPIP



Name .....

Address .....

..... Postcode .....

**INTRODUCTORY OFFER  
20% OFF**

**Focus Software Systems (UK) Ltd,**  
 10 Kellaway Avenue, Henleaze, Bristol BS6 7XR  
 Telephone (0272) 420109



## THE PCWHD



### HARD DISK UNIT

TRANSFORMS YOUR

AMSTRAD PCW COMPUTER

Into a powerful Business System without taking up additional desk space.



- |   |  |
|---|--|
| <ul style="list-style-type: none"> <li><input type="checkbox"/> 10 or 20 Megabytes Formatted Capacity</li> <li><input type="checkbox"/> Fully supported by Locomotive software</li> <li><input type="checkbox"/> Supplied with Enhanced CP/M Plus and LocoScript in which the Hard Disk Drivers are an integral part. Most European versions available.</li> <li><input type="checkbox"/> Very fast Access time - 85ms</li> <li><input type="checkbox"/> Transforms the Amstrad PCW8256 Word Processor to a Powerful Office Business System. Compatible with all good CP/M software.</li> </ul> | <ul style="list-style-type: none"> <li><input type="checkbox"/> Easily Installed Without Specialist Tools or knowledge.</li> <li><input type="checkbox"/> The Amstrad Expansion Socket is extended and remains available for use</li> <li><input type="checkbox"/> The Whole Upgrade system can be fed by a Single Power Cord</li> <li><input type="checkbox"/> Hard Disk Utilities Provided for Ease of Operation</li> <li><input type="checkbox"/> Newstar "Shell" and "Newspool" supplied.</li> <li><input type="checkbox"/> Supports LocoMail &amp; LocoSpell</li> </ul> |
|---|--|

10 Megabyte Hard Disk Kit  
 20 Megabyte Hard Disk Kit

£449.00 + VAT r.r.p. (U.K.)

£599.00 + VAT r.r.p. (U.K.)



Contact Ray Barber  
 Aston Science Park, Love Lane,  
 Birmingham B7 4BJ. Tel: 021-359 0981  
 Telex: 334535, Fax: 021-359 0433.

DEALER ENQUIRIES WELCOME



# ONE OF THOSE DAYS

Feeling down in the dumps? Check out your biorhythms with this quick listing, and discover if you are emotionally stable enough to tackle the other listings too

## BIORHYTHMS

by Robert Ainsley

Do you feel intellectually up to listing these 37 action packed lines of Basic? If the program won't run will you burst into tears? Would you be better getting out and tramping the hills? Well you won't know the answer to these questions until you have completed Robert Ainsley's Biorhythm program.

You can consult it first thing every morning and if things look too bad you can go back to bed again. It's much more scientific than reading your horoscope every morning, isn't it?

The theory is that we all go through cycles of ups and downs. Physically the cycle takes 23 days (you should be fit after cycling for that time), emotionally it takes 28 days and intellectually, 33 days. Everyone starts at zero at birth so if this doesn't work for you it is probably because you started life on an intellectual high or something.

The program works out a score of plus or minus 100 for each heading for any given day. Use it wisely and you can discover in advance the day when you are -100 for all three headings. On that day it might be dangerous to even touch your PCW.

By the way, please don't phone up to tell us this doesn't work because you caught the 'flu on a day that you were supposed to be +100 physically. The entire writing team is liable to be less than average mentally and emotionally for the next month or so, and we just won't be able to take it.

▼ The editor's biorhythms on a good day

```

This program will show the state of your bio-rhythms on any day
What year were you born (19??) 50
...and the month? 6
...and the day? 1

What year do you require? 87
...and month? 4
...and day? 3

Your scores for this day on a scale of
+100 (top) to -100 (bottom) are:
Physical 0 ; Emotional -22 ; Intellectual -99

Type y for another date; any other letter to stop
  
```

```

10 PRINT CHR$(27)+"E"+CHR$(27)+"H"
20 DIM mon%(12): FOR j%=1 TO 12: READ mon%(j%): NEXT
30 PRINT "This program will show the state of your bio-rhythms on any day"
40 PRINT: INPUT "What' year were you born (19?"; y%
50 INPUT "...and the month"; m%
60 INPUT "...and the day"; d%
70 PRINT: INPUT "What year do you require"; yn%
80 INPUT "...and month"; mn%
90 INPUT "...and day"; dn%
100 days%=0: FOR j%=m% TO 12
110 days%=days%+mon%(j%)
120 NEXT
130 days%=days%-d%
140 IF m%<3 AND y%=4*(y%\4) THEN days%=days%+1
150 FOR j%=1 TO mn%-1
160 days%=days%+mon%(j%)
170 NEXT
180 days%=days%+dn%: IF yn%=y% THEN days%=days%-365
190 IF mn%>2 AND yn%=4*(yn%\4) AND NOT(yn%=y% AND m%>2) THEN days%=days%+1
200 FOR j%=y%+1 TO yn%-1
210 days%=days%+365
220 IF j%=4*(j%\4) THEN days%=days%+1
230 NEXT
240 p%=days%-23*(days%\23)
250 s%=days%-28*(days%\28)
260 i%=days%-33*(days%\33)
270 pi2=6.283185
280 zp%=100*SIN(pi2*p%/23)
290 zs%=100*SIN(pi2*s%/28)
300 zi%=100*SIN(pi2*i%/33)
310 PRINT:PRINT "Your scores for this day on a scale of"
320 PRINT "+100 (top) to -100 (bottom) are:"
330 PRINT "Physical"zp%"; Emotional"zs%"; Intellectual" zi%
340 PRINT:PRINT "Type y for another date; any other letter to stop"
350 k$="": WHILE k$="" : k$=INKEY$: WEND
360 IF UPPER$(k$)="Y" THEN 70
370 DATA 31,28,31,30,31,30,31,31,30,31,30,31
  
```



# PULL DOWN MENUS

by R.S.Chadd

Now is your chance to make all your BASIC programs look really professional. This listing gives you the power of pull-down menus, just like your old LocoScript used to do. After this you won't need to write a good program – it will look so good people will be impressed anyway.

The listing given is a particularly cunning demonstration of the program's abilities though of course you can adapt it to suit your needs. The interesting line is 90 where the length is defined in the variable Ln (that is L as in lower case L, by the way) the number of options you require in op and the positioning of the top left corner of the menu in x1 and y1. Line 170 adapts the sub-menu.

You will usually want to change lines 110 and 190 unless you are really satisfied with programs that merely print out "Running Program Option" or "Running Option Subroutine".

The text to be shown in the the menu is entered in the variable ch\$( ) (see lines 60-90 and 130-160) and the

number of menu choices required can be set by the variable ch in line 470. Now sit back and be amazed.

## Locoscript Menu's Demo

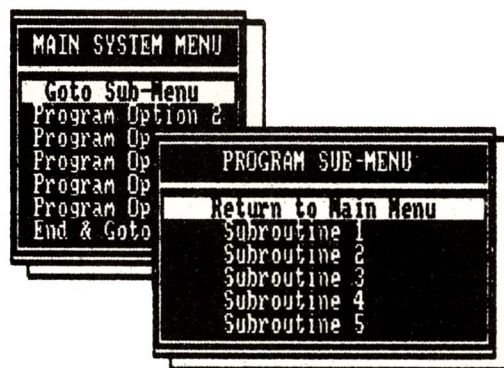

```

10 esc$=CHR$(27)
20 rev$=esc$+"p" : nrm$=esc$+"q" : cls$=esc$+"E"+esc$+"H": hom$=esc$+"H"
30 on$=esc$+"e": off$=esc$+"f"
40 DEF FNat$(x,y,a$)=esc$+"Y"+CHR$(31+y)+CHR$(31+x)+a$
50 PRINT cls$:rev$:" Locoscript Menu's Demo "
60 ch$(0)=" MAIN SYSTEM MENU ":ch$(1)=" Goto Sub-Menu ":ch$(2)=" Program Option 2 "
70 ch$(3)=" Program Option 3 ":ch$(4)=" Program Option 4 "
80 ch$(5)=" Program Option 5 ":ch$(6)=" Program Option 6 ":ch$(7)=" End & Goto BASIC "
90 ln=18:op=7:x1=3:y1=5 :GOSUB 250:REM Set up Menu
100 GOSUB 390 :REM Get Option Input
110 ON ch GOTO 130,210,210,210,210,210,230 :REM Goto Menu Option
120 '
130 ch$(0)=" PROGRAM SUB-MENU ":ch$(1)=" Return to Main Menu "
140 ch$(2)=" Subroutine 1 ":ch$(3)=" Subroutine 2 "
150 ch$(4)=" Subroutine 3 ":ch$(5)=" Subroutine 4 "
160 ch$(6)=" Subroutine 5 "
170 ln=27:op=6:x1=15:y1=10 :GOSUB 250
180 GOSUB 390
190 ON ch GOTO 60,220,220,220,220,220
200 '
210 FOR i=1 TO 8:PRINT:NEXT i:PRINT"Running Program Option ":END
220 FOR i=1 TO 8:PRINT:NEXT i:PRINT"Running Option Subroutine ":END
230 END
240 '
250 REM 'DRAW MENU
260 REM x1:y1 top left coordinate of menu
270 REM ln width of menu text
280 REM op no. of menu options
290 PRINT FNat$(x1-1,y1-1,rev$+CHR$(134)+STRING$(ln,CHR$(138)));
300 PRINT CHR$(140)+nrm$+CHR$(154)+CHR$(156)
310 PRINT FNat$(x1-1,y1,rev$+CHR$(133)+STRING$(ln,CHR$(32))+CHR$(133)+nrm$+" "+CHR$(149))
320 PRINT FNat$(x1-1,y1+1,rev$+CHR$(130)+STRING$(ln,CHR$(154))+CHR$(136)+nrm$+" "+CHR$(149))
330 FOR y=y1+2 TO y1+op+1
340 PRINT FNat$(x1-1,y,rev$+CHR$(133)+STRING$(ln,CHR$(32))+CHR$(133)+nrm$+" "+CHR$(149))
350 NEXT y
360 PRINT FNat$(x1-1,y1+op+2,rev$+CHR$(131)+STRING$(ln,CHR$(138))+CHR$(137)+nrm$+" "+CHR$(149))
370 PRINT FNat$(x1,y1+op+3,CHR$(147)+STRING$(ln+1,CHR$(154))+CHR$(153))
380 RETURN
390 '
400 REM ch no. of option required
410 PRINT off$
420 PRINT FNat$(x1,y1,rev$+ch$(0)+nrm$)
430 FOR n=1 TO op:PRINT FNat$(x1,y1+n+1,rev$+ch$(n)+nrm$):NEXT n
440 ch=1
450 PRINT FNat$(x1,y1+1+ch,ch$(ch))
460 in$=INKEY$:IF in$="" THEN GOTO 460
470 IF in$=CHR$(13) THEN PRINT on$;:RETURN
480 IF ASC(in$)<>31 AND ASC(in$)<>30 THEN GOTO 460
490 IF ASC(in$)=31 AND ch>1 THEN GOSUB 520:ch=ch-1:GOTO 450
500 IF ASC(in$)=30 AND ch<op THEN GOSUB 520:ch=ch+1:GOTO 450
510 GOTO 460
520 PRINT FNat$(x1,y1+1+ch,rev$+ch$(ch)+nrm$):RETURN

```



# ROMAN CALCULATOR

by SW Keen

What use is a Roman numeral calculator in this computer age? Well, if you have been intrigued by the '© MCMXXLVI' at the end of the old films and programmes on TV, you can find out how old they really are (significant they can't admit it was made in 1936 in the credits like normal people would).

Anyway, here's a listing for any Romans reading 8000 Plus. Would you be able to do without this program?

```

20 FOR i=1 TO 7:READ r$(i):NEXT i
30 FOR i=1 TO 7:READ n(i):NEXT i
40 INPUT"ROMAN NUMERAL ";rom$:rom$=UPPER$(rom$)
50 q=LEN(rom$)
60 last$=MID$(rom$,q,1)
70 FOR i=1 TO 7
80 IF last$=r$(i)THEN number= n(i):temp=n(i)
90 NEXT i
100 FOR i=q-1 TO 1 STEP-1
110 last$=MID$(rom$,i,1)
120 FOR j=1 TO 7
130 IF last$=r$(j) THEN no=n(j):IF n(j)>=temp
    THEN number=number+no ELSE number=number-no
140 NEXT j:temp=no:NEXT i
150 PRINT number
160 DATA I, V, X, L, C, D, M
170 DATA 1, 5, 10, 50, 100, 500, 1000
  
```

## How to type a listing in

The first thing is to load up Mallard Basic. To do this, turn on the PCW (or reset it with [SHIFT]+[EXTRA]+[EXIT]) and into the top drive put the CP/M startup disc, which is the other side of the LocoScript startup disc.

When you get the A> prompt, type BASIC, and after a few seconds a message about "Mallard-80 BASIC" appears and it says "Ok". Now copy out each line in the listing very carefully, including the line numbers, and press [RETURN] at the end of each line. Be careful to distinguish between capital I and the digit 1, O and 0, and colons and semicolons. During a long listing it's important to save your work every 15 minutes or so. And for all listings you must save them for attempting to run them. To do this, find a work disc you can write to, put it in the disc drive, and type SAVE "PROGRAM" [RETURN]. Or you can choose any other name instead of the word "program".

When you've finished, type LIST [RETURN] and the whole program will appear on the screen. Check it, and if any lines are wrong, you can correct them with the line editor. For example, if the mistake was in line 100, you would type EDIT 100 [RETURN], and use the cursor keys and delete keys to fix the line. Press [RETURN] when the line is correct.

If you have mistyped a line number, so that a line appears in the wrong sequence, just type the incorrect line number and the [RETURN], which effectively deletes the line, then retype the line with its correct number.

When you're satisfied the listing is correct, SAVE the finished version (see above) and now your program is ready to run. Just type RUN [RETURN]

And yes...it goes wrong! It's more than likely, no matter how meticulously you copied the listing out, that the first time you run the program it won't work properly. You may get some arcane message like "Syntax error in 100". List the program out (using LIST), and carefully check the screen against the original in the magazine.

Incidentally apart from Syntax errors, the line number mentioned in the error message isn't necessarily where the error is located - it's simply the point at which the computer gets stuck. You may have to look elsewhere for the error.

When you've found it, either retype the line wholesale, or correct it by using the line editor as described above. Type RUN again, and hopefully it works this time. If not, go on correcting and re-running until it does. Finally, don't forget to save the corrected version again.

When you've finally finished with the program, typing SYSTEM [RETURN] returns you to CP/M.

To run the program, another day, start BASIC up normally, put the disc you saved the program on in the drive and type LOAD "PROGRAM" [RETURN] or whatever name you gave the program when you saved it. Then as before, when it says Ok, type RUN [RETURN].

# GRAPHS

by Mohammed Afsar

So you think that all Logo can do is draw pretty pictures, do you? Well Mohammed Afsar has come up with a clever little program to plot any function of x on axes between any specified limits of x.

Why Logo? Well although there are ways of producing graphics in Basic without using GSX they cannot really be described as simple. It would be the work of a moment to do this in GSX but if you haven't used GSX before it might take a bit of time to set it up. In this case Logo is a much simpler answer.

You can define the function in the procedure f x. In this example Mr Afsar has given us a simple cosine curve -  $y = \cos(x)$ . This can be changed by redefining f x. You do this by typing t o f x [RETURN]. You then type m a k e "y and specify your function, for example : x \* : x (for  $y = x$  squared) or ( s i n : x ) \* ( s i n : x ) (for  $y = \text{sine-squared } x$ ). It can be as long as you like but it must do the job of assigning a value to the variable y. You finish with e n d, of course.

You need to input four pieces of information to run the procedure 'graph'. 'Step' gives the resolution of the graph (the number of pixels per interval of x) so a low step (say 10) gives a high resolution and vice versa. Then you need 'min' and 'max' which suitably enough define the range that x is to take.

'Amp' is the magnifying factor of the variable y so that the shape of the graph can make best use of the space available. If you enter 0 it chooses a suitable 'amp' itself.

For example, So to run the program you just type g r a p h then step, min, max, amp. In the example shown we used g r a p h 15 - 90 270 0. Play around and see what clever things you can do with it.

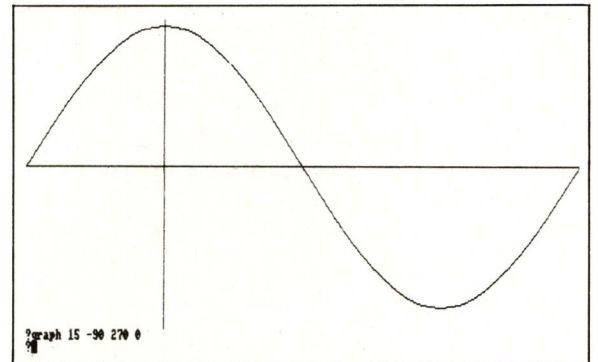

```

to graph :step :min :max :amp
  pu home ht setsplit 2 rt 90 wrap pd fd 1000 home
  make "hi 0
  if :min < 0 [vaxis] if :min = 0 [vaxis]
  make "inc (:max - :min) / 720 make "x :min make "c -360
  make "inc :inc * :step
  if :amp = 0 [repeat (720 / :step) + 1 [amplify]]
  if :amp = 0 [make "amp 200 / :hi make "x :min]
  window fx pu setx :c sety :y * :amp pd
  repeat (720 / :step) + 1 [make "coord []
    make "coord (lput :c :coord) fx
    make "coord (lput :y * :amp :coord)
    setpos :coord make "c :c + :step make "x :x + :inc]
  end

to vaxis
  make "p (:min / (:max - :min)) * 720
  make "p 0 - 360 - :p pu setx :p pd fd 500 pu home
  end

to amplify
  fx
  make "z :y if :z < 0 [make "z 0 - :z]
  if :z > :hi [make "hi :z]
  make "x :x + :inc
  end

to fx
  make "y cos :x
  end
  
```







# TIP-OFFS

TipOffs – the pages where you get the inside knowledge on how to turn your PCW inside out

This month's tips cover LocoScript and CP/M, baby-bottles and Blu-Tac – the heights that modern technology has risen to are truly amazing. The two prizewinners, who can expect a £30 cheque to land on their doormat, are David Tyler of Islington for his LocoScript mailmerger which is actually *useful*, and Stewart McCall for revealing how to pack more than 64 files onto a single-sided disc.

Surely you've got a secret about your favourite program? Be it LocoScript, a database, a graphics program – any commercially available software or hardware, we want to tell our readers. Tell us how to tell them at *TipOffs, 8000 Plus, The Old Barn, Somerton, Somerset, TA11 7PY* – the best tips get £30 each month.

## Dumpy dumps

Feeling depressed because your Logo artwork is coming out dumpy? Are your squares rectangles and your circles ovals? Well here is the answer. Type in the command

```
setscrunch 0.5 [RETURN]
```

This changes the screen's aspect ratio, making the picture on the screen slightly higher than it is wide. So the screen dump actually

comes out with square squares and circular circles.

To return to the default aspect ratio type in `setscrunch 0.468 [RETURN]` and everything is back to normal. The `setscrunch` command won't affect the saved Logo picture. They will have the same aspect ratio as they had when they were created.

*Sue Jones, Shrewsbury.*

## Dear Diary

Following on the article by David Ford in our February issue, when he spoke of a Diary program he had written in Basic that automatically appeared whenever he started up his PCW to tell him all his appointments for the week, here is a tip to do the same thing only using NewWord.

If you make up a NewWord boot disc which contains a PROFILE.SUB file (as detailed in our October issue) all you need to do is create a file called DIARY on that disc.

Add the command `<DDIARY` to the Profile.Sub and NewWord will call up the Diary automatically. Don't leave a space between the D (for document) and the D of Diary, or NewWord will not recognise the file name. You can make this Diary fit your own needs on a daily, weekly or monthly basis. It is a good idea not to give yourself too long a list of tasks, or depression may set in before you touch a key.

*M. McManus*

## One more time

A recent query from a reader concerned the possibility of bringing the previous line of a Basic program back on to the screen without going through the 'Edit line' procedure. `[ALT]+A` will display the previous line for editing if one has been reckless enough to hit `[RETURN]` before checking the line.

*Margaret Rugg, Exeter.*



## Ode to Batman

The bouncing mat goes on the monster's head,  
but the peacock goes onto your head.

Make sure you move off the moving raft,  
And take the pressie into the Batcraft.

*John M Sorsby, Farnham*

## DIY hardware kit

There seems to be a plethora of useful but expensive hardware add-ons appearing on the market just now. Not everybody can afford to buy all the gadgets to prevent back-ache, eye-strain, heart attacks, bruised knuckles (from punching the screen) and the like. Here are some cost-cutting solutions to everyday problems:

### Thingi

You will need a ruler which is about 15 inches long, a bulldog clip and a lump of Blu-Tac (doesn't this remind you of Blue Peter?). Stick the clip on the end of the ruler with the Blu-Tac, and simply resting the ruler on top of the monitor will be firm enough to hold single sheets. More than one sheet and you may need to anchor the ruler.

### Disc Box

Snowed under with discs? Your storage problems are a thing of the past. Simply rip the top off a cassette box (generally available if you buy ten tapes at a go) and the carton will perform superbly as a container for up to 23 discs.

### Printer noise

Instead of a cover to silence the printer, how about wearing ear-plugs? These not only reduce the chatter of 'dots being matrixed', but also dramatically cut down on inane conversations with other users. A similar solution is to connect yourself by headphones to the nearest stereo.

### Keyboard cover

Instead of investing in a plastic keyboard cover, drink your coffee through a baby-bottle.

### Screen filter

Do some lateral thinking. Rather than buying a screen filter, use an eye filter – wear sunglasses.

*Jeremy Lloyd, Newcastle-upon-Tyne*

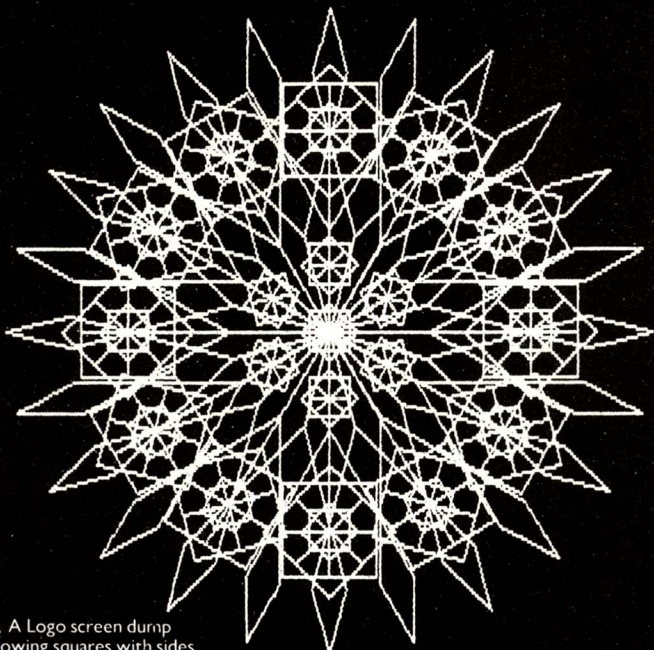

▲ A Logo screen dump showing squares with sides of equal length!



## LocoScript mailmerge

For many mail-merging applications all that is required is the simple substitution of names and addresses, or a different name at the start of the letter ("Dear..."). You can do this easily using the standard features of LocoScript, without forking out for LocoMail.

The key is to type in the main body of the text within the header and footer zones and leaving the text zone free for the merge data (the variable bits), with each record on a new page. Most of the standard LocoScript features are available when entering or editing text here and the documents are just as easy to create in this section as in the main editing text.

You just keep a file on disc containing the names and addresses of the people you are writing to, in a suitable format for printing address labels (eight lines per page with a separate name and address on each new page.)

Copy this file in to a new file,

press [f7] and select the 'Edit Header' option. Pressing [f7] twice more gets you to the 'Page Size' menu. If you are using A4 paper (with a page length of 70 lines) for instance you will need a page body of eight lines to accommodate the names and addresses. Allowing for the usual nine lines of header this means a footer zone of 53 lines starting at position 18.

Make sure you pick the 'All pages same' option from the pagination menu and then decide what you want in your header zone (an eye catching heading or even a short address maybe). When you are sure everything is right [EXIT] and select 'Save and Print'.

Out will come the same number of pages as you have addresses each with the name and address of the person in the right place. It might be wise to experiment to get the results looking the way you want them.

David Tyler, Islington, London.

## If it's Tuesday, it must be 1978

The CP/M utility DATE is used to set the system clock and help in time stamping files. But there is another cunning use for it – you can tell what day of the week any date will be between 1st January 1978 and 31st December 1999.

Assuming you have DATE.COM on your current drive, type DATE SET, and tell it the date you want. Skip the time setting part by just pressing [RETURN] when it asks you.

Now when you type DATE, the PCW will tell you the day as well! It won't work for any year before 1978 or after 1999, though if you set the time and date to a few seconds before midnight on 31st December 1999, and type DATE C, you will find out that the first day of the new century will be a Saturday.

Nigel Thomas, London W14

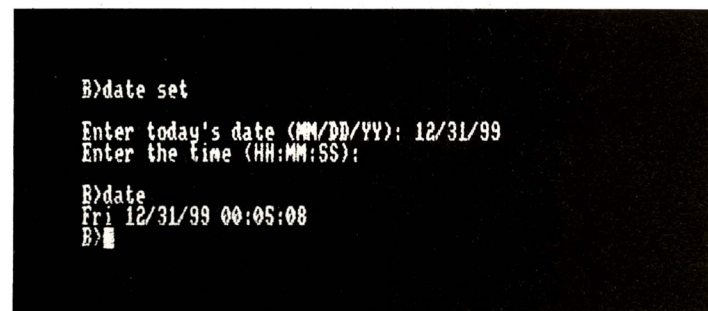

## Paginating in LocoScript

The LocoScript pagination menu has an annoying restriction if you are printing out documents with a title page. You don't want any header or footer on the title page, and you want the final page of the document to say 'ends' in the footer, but unfortunately you can't have both the first and last pages different from the body pages.

Type a standard title page into the TEMPLATE.STD, and choose 'last page differs' on the pagination options. But also disable the header and footer for page 1. Now the page numbering will start from the second sheet, and the last page will be different.

LocoScript assumes that the title page is page 1, so starts numbering from page 2. This is annoying, so if you put a zero in the 'First page number' slot, the page after the title page is numbered 1 as it should be.

PA Tillin, Exeter

## Running programs automatically

Although seasoned '8000 Plus'ers will have seen earlier tips on making up discs which automatically load programs, there are many new readers to whom it is still a black art.

To recap then, it is possible to instruct CP/M that it should automatically execute a series of commands (for instance, to run your word processor or spreadsheet) every time it starts up. 'Starting up' CP/M is called 'booting up' in the trade, and discs which automatically execute

commands on booting are called 'auto-boot discs.'

To make an auto-boot disc, format a spare work disc and, from your master CP/M disc, copy (using PIP) onto it the files J14CPM3.EMS and SUBMIT.COM. Now, if you want your PCW to automatically run SuperCalc 2 every time it starts, take your SuperCalc work disc and copy all the program files (SC2.COM and so on) onto the new work disc – the SuperCalc manual should tell you which files you need to run the program.

Finally, with an editor like RPED (see the Amstrad manual for details), or any other word processor capable of creating ASCII files, create a file called PROFILE.SUB. Every command you type into this will be treated as a CP/M command line when CP/M starts up, so to run SuperCalc just type into it the single line S C 2, and save the file on your new disc.

Now reset the PCW and put your new disc into the top drive. Automatically, CP/M starts and SuperCalc runs. What has happened is that when CP/M woke up, it looked for the PROFILE.SUB file and obeyed all the commands there just as if you had typed them at the keyboard yourself.

There are a couple of pitfalls. The top drive discs can only hold 173k of files, and the J14CPM3.EMS file which you need takes up 40k itself. Therefore, if your SuperCalc program files take up more than 130k or so you will be unable to use this method. At least keep your data files on a separate disc.

Finally, make sure the new disc is not write protected, or the auto-boot process will not work.

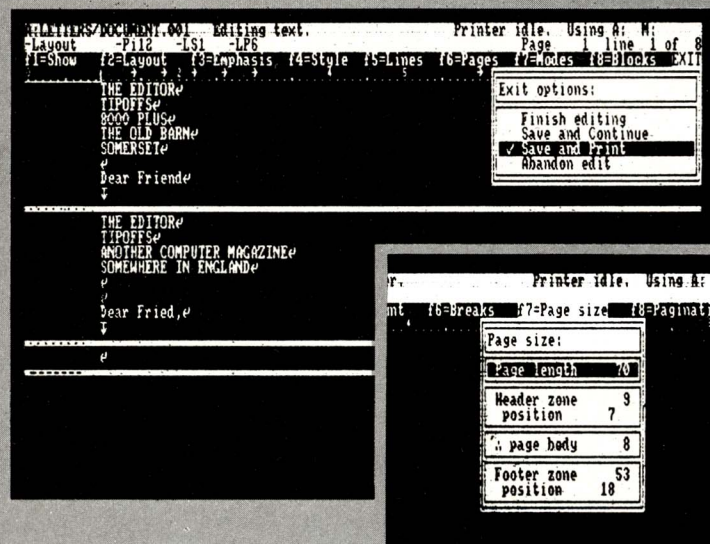
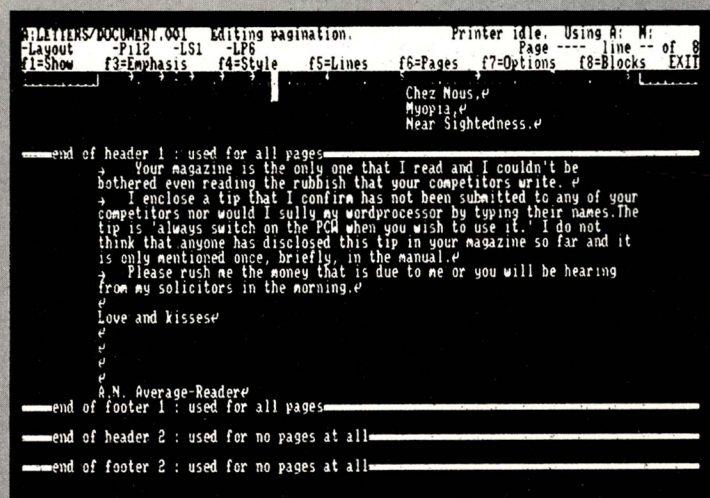



## More disc space

Single density discs can't store more than 64 files before the directory becomes full. Small letters may only take up 1k each, so if you have 64 of those you will have a full disc with 120k of free space. What a waste.

With the aid of the dreaded SID, you can alter the discs so that you get more files per disc – you will never get more than 173 files per disc since each file takes up at least 1k.

The modification to make is to DISCKIT, so that any discs formatted with the modified DISCKIT will have the expanded directory space.

First, take a work disc containing DISCKIT.COM (from side 2 of the master discs) and SID.COM (side 3). Put it in the drive and type S I D.

Now follow the keystrokes below – for *code* and *check* see the table.

▼ The steps in using SID

```
B)SID
CP/M 3 SID - Version 3.0
#RDISKIT.COM
NEXT MSZE PC END
1D00 1D00 0100 DAFF
#S19C7
19C7 02 04
19C8 2A
#S1BBF
1BBF CF C9
1BC0 03
#NEWDK.COM
3C38h record(s) written.
#TC
B)█
```

▼ DIR [FULL] on a newly formatted disc – 128 directory entries allowed

```
A)dir [full]
Scanning Directory...
Directory For Drive A: User 0
Name Bytes Recs Attributes Name Bytes Recs Attributes
DIR COM 15k 114 Dir RW
Total Bytes = 15k Total Records = 114 Files Found = 1
Total 1k Blocks = 15 Used/Max Dir Entries For Drive A: 1/ 128
A)█
```

## Making music

Anyone involved with producing quantities of sheet music (for a choir or orchestra) will be interested in the ability of the PCW to produce sheet music in LocoScript. Although not yet up to putting the notes into the right places LocoScript will produce excellent staves for writing music.

You can produce as many as you need, where you want them on the page and lined up neatly with LocoScript lyrics.

The basic staff is produced by choosing  $\uparrow$  linespacing and underlining. Type  $\uparrow$  LS  $\uparrow$  UL.

```
RDISKIT.COM
S19C7
code
.
S1BBF
check
.
NEWDK.COM
[ALT]+C
```

What you type for *code* and *check* depends how large you want the directory to be:

Directory size	code	check
32 files	01	CC
64 files	02	CF
96 files	03	CE
128 files	04	C9
160 files	05	C8
192 files	06	CB

The trade-off is that every 32 extra entries takes up 1k of disc space. Thus with only 32 files allowed per disc, you get 174k of free space, but with 196 entries you only get 169k free after formatting.

So, once you have chosen the directory size you want, have put the right pair of *code* and *check* values into SID and saved it, you have a file called NEWDK (for 'new Disc-Kit'). Whenever you want to format a disc, use this rather than DISCKIT. It will appear to be exactly the same as DISCKIT when you run it, but will give you the directory size you wanted.

These discs are compatible with LocoScript.

Stewart McCall, Corby

## Improved indexer

Keith Gibson's magazine indexing program (March '87 issue) is simple, fast and very useful.

However, it is unforgiving with errors while you type the data in, and a bad error means entering a whole month's data from scratch, and can leave two entries for the same month in the INDEX file.

A less painful way of entering the index data is to use the RPED text editor. When you type in data, you give the issue a title, year and month like ET, 86, OCT. The indexing program then stores all the information you type for that issue in a file called "ET86OCT" – ie the concatenation of the three abbreviations.

If you have already used the

program to index a few issues, have a look at the disc (with DIR) and then type one of these files on the screen – use TYPE ET86OCT for the example used before.

You will see all the data stored like this: "Feature Title", "Contents", "Page"

Using BASIC and the RPED editor (described in the PCW manual) you can edit these files directly. You can correct typing mistakes made previously, and you can add new entries in. You must make sure that the format of Title, Contents, Page is used on any new entries – all enclosed in double quotes.

AJ Clarke, London EC2Y

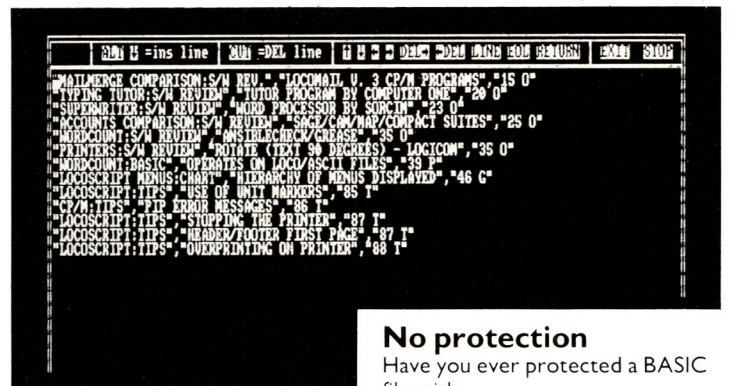

▲ A look at RPED while you modify an index file from the magazine indexer program.

## Spectravideo joystick

The Spectravideo joystick pack for the PCW, the one that comes with a copy of 'Tomahawk', is a little short on documentation – ie. there isn't any about the joystick itself. In fact, the joystick addresses I/O port 224, which can be read in Mallard BASIC with the INP command:

```
10 stick=INP(224)
```

or suchlike. If the interface is not plugged in, *stick* will have a value of 255, but is 96 when the joystick is connected. The diagram shows the different values *stick* will take depending on the position of the joystick lever.

If the 'fire' button is being pressed, all these values are increased by 2.

Paul Western, Southampton

## No protection

Have you ever protected a BASIC file with

SAVE "filename", P so that you can't get at the listing, and then discovered there is still some work to be done? Fine if you have another copy of the program, but many people are left desperately trying to find some way of unprotecting their programs, staring at the 'improper argument' error message after a LIST command.

If you have a protected file, start BASIC up afresh (or type NEW). Now type

```
SAVE "TEMP",A
```

in effect creating an empty file. LOAD your protected program, and then type

```
MERGE "TEMP"
```

This adds in the empty file, which has no effect on the program. Since the empty file was unprotected, the protection for the whole lot is reset and you can list out the program and resave it normally.

T.F. Potten, Llangollen

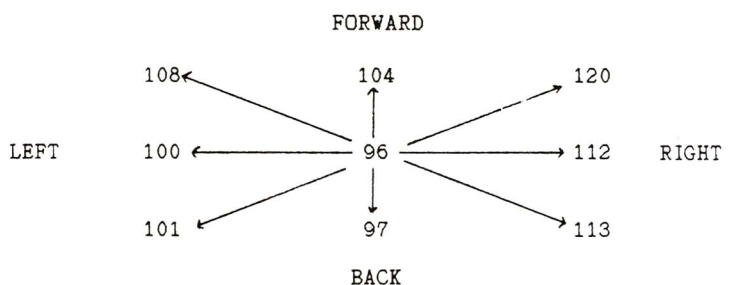







# FRONT RUNNER

Continuing his look at Public Domain (free!) software, Frank Peters finds a way to cut out CP/M altogether

## Installing

Installation or patching is the process of inserting the correct screen control codes into a program so that it can control and move the cursor correctly and switch on or off inverse video or underlining. The program will also need to know what characters are returned from the keyboard when certain keys are pressed.

Last month I had a look at a useful program that was able to be run straight away. This month I will be looking at how to use a program which has to be 'installed' first.

FRONT50 is a menu driven replacement for the CP/M prompt 'A>'. Some of you may be familiar with a program call SHELL, which is very similar but not Public Domain. FRONT50 will totally remove the need to ever see the dreaded CP/M command prompt ever again!

When you run it, you are presented with a menu showing a list of .COM files available on the disc. Also shown are any other filetypes that you have optionally installed as allowed to be shown, like .BAS for example. If the disc has a disc label, this will be shown also.

You can then run a program directly from this menu, rather than using CP/M's commands. On finishing the program, FRONT50 will reload itself from the A disc and give you its menu again.

## Sssh! It's a library

A package or group of files that belong together are usually placed inside a common file called a library and use the filetype .LBR to distinguish them as such. This grouping of files is done by

the originator of the files, and all you have to do is remove them from the library using a program called DELBR.COM.

There are two methods of using the program. You can move the cursor over the file to be run, or you can enter the first letter of the file. This latter choice will then cause FRONT50 to blank out all the files on the disc that do not begin with this letter. With this 'short-list' you can then type in the second character, thus shortening the list still further until you are left with one file. Even though at this stage you may have not typed in the full filename, you can now press [RETURN] to run that remaining program.

If the program you have chosen needs optional parameters (ie. more words after it on the command line), just type a space and continue typing until you have finished inputting then [RETURN] to run it.

## Where to go

If you want to get hold of Public Domain software, there are three sources which may interest you.

The CP/M user group publishes a quarterly newsletter and runs a vast software library, though not all of it relevant to PCW users. The software is free, but there is a membership fee and a copying fee per disc. Send a large SAE to: The Secretary, CP/M User Group, 72 Mill Road, Hawley, Dartford, Kent DA2 7RZ.

PD Software can also supply a large range of public domain programs, again with administration charges. Write to: PD Software, Winscombe House, Beacon Road, Crowborough, East Sussex TN6 1UL.

If you have a modem, you can download software from my bulletin board (among others). This is active between 10 pm and 8 am each day, phone number 0462 700893.

One clever point about FRONT50 is its ability to realise that if you try to run a .BAS file, you need to actually run up BASIC first, then run the BASIC program. This it will all do for you.

## Getting ready

FRONT50 was originally written for various American computers. If you get your copy of FRONT50 from my Langford ROS bulletin board (see the box for the phone number), you can get an extra 'terminal definition' program inside the library called FINSTPCW.COM. This helps quick and easy installation of this useful turn-key program for the Amstrad PCW.

The programs come bundled together as a 'library', and need to be separated out first of all. The programs you will need straight away are FRNSTL50.OOJ, FRONT50.OBJ and FRONT50.DQC. You may have noticed by now the Q in the centre character of the filetype - this shows that the file has been squeezed. You will have to first use a utility like NSWP2 (covered last month) or UNSQ to recover these files.

The next step is to print out the informative and very useful 12 page document file FRONT50.DOC and to 'TYPE' the READ.ME file for the latest information. Of course if you have NSWP2 then all you have to do is use the 'p' command and it will unsqueeze and print it at the same time!

Most American programs residing on Bulletin Boards usually have a filetype of .OBJ which stands for 'Object code', rather than the .COM CP/M filetype. The first thing to do is to rename them:

```
M>REN FRONT50.COM=FRONT50.OBJ
```

```
M>REN FRNSTL50.COM=FRNSTL50.OBJ
```

FRONT50 is pleasantly easy to install, unlike much PD software. Simply run the program FRNSTL50 and you will be provided with step by step instructions to complete installation. There is a useful '?' command for when you get stuck, giving hints on what to do.



The terminal names shown are all American of course but 'Zenith' is very close to the PCW8256 screen codes. The only problem comes when you try to use the cursor keys. There are two ways to cure this problem: you can either write a short SETKEYS file with the following:

```
left arrow = ^H
up arrow = ^L
right arrow = ^K
down arrow = ^J
```

or you can use the special PCW version from my bulletin board.

## GO!

Having safely stored your original .LBR file and your freshly installed version onto a 'master' disc, copy FRONT50.COM onto your turn-key disc. If you are already using a turn-key disc, enter A:FRONT50 as the very last line in the PROFILE.SUB file. You may never again see the 'A>' prompt!



# THE WORLD OF DESKTOP PUBLISHING ON YOUR AMSTRAD PCW



Fleet Street Editor Plus brings desktop publishing to your Amstrad PCW 8256/8512. Now you, too, have a professional, low-cost alternative to expensive and time-consuming typesetting and artwork services.

## Use Fleet Street Editor Plus to create

- Multi-column newsletters and publications
- Advertising layouts and brochures
- Business reports and contracts
- Promotional literature and specification sheets
- Flyers
- Organisation charts and flow charts
- Invitations and announcements
- Menus, cards, letterheads and much more

Fleet Street Editor Plus is flexible, yet very easy to use. Using a what-you-see-is-what-you-get principle, page layout and design becomes second nature.

## Page make-up

- Full page composition with multiple columns
- Left and right hand page orientation and automatic page numbering for multiple page documents
- Text editing and picture sizing/cropping in page make-up
- Linked text blocks
- Variable page sizes and column widths
- User-created and editable page dummies

## Text handling

- Type directly into the text editor or read in from an ASCII word processed file
- Automatic word wrap
- Justification or proportional spacing
- Variable line leading
- Five different fonts in varying sizes and styles

## Graphics

- Full feature studio package for graphic creation and manipulation
- Accepts lightpen input
- A library of ready-to-use graphic images
- Facility to import graphics screens from other software packages

## Output

- Dot matrix

## Handling Features

- Pull-down menus
- Optional mouse control
- File management structures
- Hot-line support for registered users

## System Requirements

- Amstrad PCW 8256 or 8512
- PCW or Epson-compatible printer with Centronics interface

## Optional

- Kempston mouse
- Electric Studio lightpen

PUBLICATION: MARCH

PRICE: £69.95

**MIRRORSOFT**

If you would like to receive more information on Fleet Street Editor Plus for PCW write to Dept. FSE, Mirrorsoft Ltd, Freepost (BS4382), Paulton, Bristol BS18 5BR  
Telephone enquiries: 01-377 4645



# A PROCESS OF WORD PROCESSING:

**Are you 100% delighted with your Word Processor?  
Have you got any choice?**

Well until now, perhaps not, but read on because we have some interesting facts for you. We have tested some of the more popular word processors for the Amstrad PCW machines and we have presented a fairly comprehensive listing of our findings. Use this information freely, before you decide on your next Word Processor.

## A Comparison of Amstrad Word Processors

### Benchmark timings

All tests were carried out on a standard 1817 word document. Tests 7 to 10 were carried out on a standard 262 word paragraph. All times are in seconds.

	Protex	Loco- script	Tasword 8000	Newword	Pocket Wordstar Deluxe
Version:	2.00	1.20	1.00	2.17	3.05
Computer:	PCW8256	PCW8256	PCW8256	PCW8256	PCW8256
1. Load document	6	12	8	18	10
2. Save document	7	84	19	13	19
3. Merge document to middle of itself	5	269	11	21	11
4. Move cursor from start to end	0.5	34	6	3	4
5. Move cursor from end to start	0.1	15	3	4	3
6. Replace 'the' with 'THE' 205 times	5	128	297	73	208
7. Format paragraph	1	10	12	6	6
8. Move paragraph to start	0.2	42	13	9	9
9. Move paragraph to end	1	80	13	9	4
10. Delete paragraph	0.3	19	3	5	4

**"I am stunned by the speed at which Protex performs the text operation, there is nothing like it on the Amstrad" . . . AMTIX MAGAZINE**

**"Protex can thrash any 8 bit Word Processor for speed and can even cross swords with some 16 bit programs for power" . . . POPULAR COMPUTING WEEKLY.**

## PROTEXT WORD PROCESSOR

**Q: So why is Protex so much faster than the competition?**

**A:** Protex is the "state of the art" on the Amstrad computers. After two years of development, it is now widely recognised as the "new standard" by which other programs will be judged. Protex is not "just another conversion" from other computers but is a complete word processing system designed and written specifically for the Amstrad range. Protex makes full use of the available features on your machine, taking it further than ever before in many respects, by increasing the speed, power and performance, which until now, has not been thought possible. Protex is a fully integrated package complete with extensive mail-merge routines, spelling checker and disc utility programs.

**But speed is not everything, so to be fair we should also show a summary of the main features. . . .**



# ELIMINATION

## THE FACTS EXPOSED

### Feature comparison

FEATURES	Protex	Loco-script	Tasword 8000	Newword	Pocket Wordstar Deluxe
What you see is what you get	y	y	y	y	y
Works with any printer	y	-	y	y	y
Unlimited file size	y	y	-	y	y
Two file editing	y	-	-	-	-
Auto re-format	y	y	y	-	-
Layout commands stored in text	y	y	-	y	y
Spelling checker	y	-	-	y	y
Spell check from within WP	y	-	-	-	y
Find/anagram options	y	-	-	y	-
Background printing	y	y	-	-	y
Insert or overtyp	y	-	y	y	y
Delete line command	y	-	y	y	y
On screen help	y	y	y	y	y
Dynamic screen update	y	y	-	-	-
Headers and footers	y	y	y	y	y
- different even and odd	y	y	-	y	y
Soft hyphens	y	y	-	y	y
Soft spaces/returns	y	y	-	y	y
Non break space	y	y	-	y	y
Decimal tabs	y	y	y	y	y
Format whole document	y	-	-	-	-
Page break indication	y	y	y	y	y
Page/line number display	y	y	y	y	y
Column manipulation	y	-	-	y	y
Column replace mode	y	-	-	y	-
Multiple block buffers	-	y	-	-	-
Undelete block	y	-	-	y	-
Undelete line	y	-	y	y	-
Save block	y	y	-	y	y
Calculator	y	-	-	-	-
Print multiple copies	y	-	y	y	y
Print selected pages	y	y	-	y	y
Print block	y	-	y	-	-
Print to screen	y	-	-	y	y
Typewriter mode	y	y	-	-	-
Change printer at any time	y	-	-	y	y
Embedded printer codes	y	y	y	y	y
Print translated characters	y	-	y	-	-
Turn off printer code display	y	y	-	y	y
Display returns/tabs	y	y	-	-	-

FEATURES	Protex	Loco-script	Tasword 8000	Newword	Pocket Wordstar Deluxe
On screen underlining	-	y	-	-	-
Built in Foreign characters	y	y	-	-	-
Separate accents	y	y	-	-	-
Catalogue files	y	y	y	y	y
Delete file	y	y	y	y	y
Rename file	y	y	y	y	y
Copy file	y	y	-	y	y
Format disc	y	-	-	-	-
Type disc file	y	-	y	-	-
Auto file backup	y	y	y	y	y
Find/replace - wildcards	y	-	-	y	y
- selective or all	y	y	y	y	y
- ignore case or not	y	-	y	y	y
- search for any string	y	-	-	y	y
- search for control codes	y	-	-	y	y
- find nth occurrence	y	-	-	-	y
Mail merge - data from file	y	-	y	y	y
- data from keyboard	y	-	y	y	y
- re-usable variables	y	-	-	y	y
- string/substring expressions	y	-	-	-	-
- numeric arithmetic	y	-	-	y	-
- polymorphic operators	y	-	-	-	-
- multiple data files	-	-	-	-	-
Conditional printing	y	-	y	y	y
- nested	y	-	-	y	y
Repeat/until loops	y	-	-	-	-
Insert file whilst printing	y	-	-	y	y
Format whilst printing	y	-	-	y	y
Auto widow/orphan elimination	-	y	-	-	-
Keep lines together	-	y	-	-	-
Microspacing	y	y	-	y	y
Proportional spacing	y	y	-	-	-
Built in word count	y	-	y	-	-
Character count	y	-	y	-	y
Place markers	y	y	y	-	y
Comments within text	y	-	-	y	y
Program editing mode	y	-	-	y	y
Create ASCII file	y	y	y	y	y
File conversion utility	y	-	-	-	-
User definable keys/phrases	y	y	y	-	-

Arnor Ltd. September 1986

## PROTEXT: THE PROFESSIONALS CHOICE

"The best Amstrad WP at any price" . . . YOUR COMPUTER

"They took their time with it and it was worth the wait" . . . AMSTRAD COMPUTER USER

"Don't miss it - it is superb". . . POPULAR COMPUTING WEEKLY

### WHY USE ANYTHING ELSE ?

Protex for the Amstrad  
PCW 8256/8512 and CPC6128 £79.95

Special price available for Prospell users  
Phone for details



Arnor Ltd. (Dept. RBN )  
118 Whitehorse Road,  
Croydon, Surrey  
CRO 2JF  
24 hr 01-684-8009

Amstrad CPC versions available on disc or ROM  
Phone for details and FREE catalogue. Dealer enquiries welcome.  
**Protex is available from Arnor Limited. We do not stock the others!**



# STOCKMARKET

THINKING OF INVESTING? ALREADY AN INVESTOR?

STOCKMARKET enables you to record details of purchases, sales and dividends of shares, unit trusts etc. Current share prices can be entered very easily at any time for an automatic folio revaluation. Values of share prices, indexes etc can be recorded, listed and plotted along with moving averages. Practise buying and selling shares. See if your intuition is right.

## PRICES

- \* Store values of share prices, indexes, exchange rates etc.
- \* Up to 260 prices per share (eg. weekly prices for 5 years).
- \* Tabulate prices.
- \* Plot prices and moving averages with log or linear scales.
- \* Actual prices supplied as demonstration data (inc FT 30, British Telecom).
- \* Use curves to select best buying and selling opportunities.

## ACCOUNTS

- \* Record full details of your portfolios of stocks, shares, unit trusts etc.
- \* Practise buying and selling techniques and accurately record your progress.
- \* Up to fifty shares per folio. Store many folios on one disc.
- \* Buy and sell shares with automatic calculation of dealing costs.
- \* User definable dealing costs.
- \* Record dividend yields and price earnings ratios.
- \* Update prices and automatically update yields, P/E ratios and recalculate individual share and total folio value.
- \* Record dividend payments, total dealing costs and keep cash accounts.
- \* Tabulate present folios, past transactions, dividends and cash accounts.
- \* Demonstration data supplied. Comprehensive forty page manual.

CPC 464 (disc)/664/6128  
PCW 8256/8512  
Price: £29.95 (inc. p&p)

**MERIDIAN**  
software



38 Balcaskie Road,  
London, SE9 1HQ.  
Tel: 01-850 7057

## AMSTRAD SOFTWARE FOR THE SMALL BUSINESS

- ▶ **CARD-INDEX** £34.95 Incl. Vat  
Re-Creates a Card-Index System On Your Computer
- ▶ **SIMPLE ACCOUNTS** £34.95 Incl. Vat  
Book-Keeping Made Easy For The Small Business
- ▶ **JOB ESTIMATING** £49.95 Incl. Vat  
Calculates and Prints Estimates and Quotations
- ▶ **PRODUCT COSTING** £49.95 Incl. Vat  
Maintains and Reports Your Manufacturing Costs



All programs supplied complete with step-by-step instruction manual and FREE user-support.



## CORNIX SOFTWARE LTD

Spirella Building, Bridge Road, Letchworth, Herts. SG6 4ET  
Telephone (0462) 682989

## LocoScript → Daisywheel

LSPrint is a brand new program which gives you direct daisywheel printout of your LocoScript documents without prior conversion to an ASCII file.

LSPrint implements all the special effects of LocoScript including word and full underlining, bold print, right justification and various character and line pitches. The program prints the full range of LocoScript characters and symbols providing you have suitable printwheels.

LSPrint runs under CP/M. is extremely easy to use with a wide range of printers and printwheels and includes a word count facility.

LSPrint costs £19.95 which includes an 8 page instruction manual.

Please state your printer type(s) when ordering from:

**Bradway Software,**  
33 Conalan Avenue, Sheffield, S17 4PG

## TEMPLATES ARE EASY

TempMate consists of a clear plastic sheet which shows a grid of margins, lines and columns. Place a form or headed stationery under the clear sheet and tabulation, margin and line positions are easily seen.

The terminology of this version of TempMate is for LocoScript users but the overlay's grid is helpful for those using other word processors.

£4.30



includes P&P (no VAT at present)  
Cheques and Postal Orders to  
**Brian T Worts**  
(Brian Thurston W.P. Tutor)



18 Danby Terrace  
Exmouth EX8 1QS  
Telex: 265871 MONREFG Reference 72:MAG 70155  
MicroLink Mailbox: 72:MAG 70155  
Telephone: 0395 277496

Distributors wanted for USA, Europe and Scandinavia

## DISC SOFTWARE TOOLS FOR AMSTRAD CP/M

We specialise in the best

Turbo Pascal 3.0 (CP/M-80) .....	57.50 ABCD
Turbo Database Toolbox 1.2 .....	57.50 ACD
Turbo-CPC Interface (windows, graphics, sound) .....	14.95 BC
Turbo Tutor .....	34.50 ABCD
Micro-Prolog 3.1 (CP/M-80) .....	57.50 BCD
FTL Modula-2 Compiler (inc. editor) .....	54.95 CD
Hisoft Pascal80 V.2 .....	39.95 BCD
Hisoft C .....	39.95 BCD
Pro-Pascal 80 .....	57.50 CD
Pro-Fortran 66 .....	57.50 CD
Write Hand Man (Resident: Diary/Calculator/Phonebook/Notepad) .....	29.95 BCD
Companion (Resident: Clock/Diary/Calculator/Phonebook/Notepad) .....	19.95 D
Database Manager (AtLast) (menu-driven multi-file) .....	29.95 CD
dBase II .....	119.00 CD
Dr Graph (Business graphs/Bar & Pie Charts) .....	49.95 CD
Dr Draw (Draughting) .....	49.95 CD
Hands On CP/M Plus (On-line tutorial) .....	24.95 D

A = Includes FREE Mailbox on OneToOne (worth £50)  
B = CPC464/664 C = CPC6128 D = PCW8256/512

VAT & P&P (Europe) included. Please state model when ordering.  
All payments in Sterling drawn on a UK account. ACCESS accepted.  
Callers please ring first.

Rational Solutions

9 Rosehill Road, London SW18 2NY

Tel: 01 874 6244

It might be! – So fit the Seal'n Type tea-proof cover and protect your keyboard. If you spill liquid on your keyboard it will probably expire! Made of clear flexible plastic, our removable Seal'n Type cover slips snugly over every key letting you type with complete ease and safety.

For only £7.50

(plus £1.25 p&p)

Seal'n Type is now available for Amstrad PCW 8512/8256 & PC 1512.

For peace of mind at the keyboard write to:

**KADO**  
PO Box 20  
Ashford  
Middlesex  
TW15 3QE

is your  
keyboard  
just your  
cup of tea?



Patent & Design  
Registration Pending



# THE GOOD SOFTWARE FILE

These pages provide a comprehensive guide to the Amstrad PCW software. Published in three monthly parts, this time it's the turn of Spreadsheets, Utility Programs and Educational Software to face the ultimate test. We've set out to cover every piece of software we could lay our hands on, and to give you enough information to decide whether they are suitable for you.

As well as a brief summary of what they do, the main Plus and Minus points for each program are listed. Those we think are particularly noteworthy have an elliptical flash on them ... have fun window shopping!



## SPREADSHEETS

See this month's Spreadsheet Survey on pages 10 to 13 for detailed descriptions and reviews.

### Job Estimating • Product Costing

£49.95 each • Cornix Software • 0462 682989

SIMPLE  
TO USE

Both these programs aim to provide help to small businesses by keeping track of costs. You break down the job/product you are doing into small units and specify the cost of each basic component. The programs then analyse your profit margins and can produce printed quotes to convince customers you are superb value.

#### PLUSES • MINUSES

- Well written manual aimed at businessmen not programmers
- Simple and robust to use
- Changes in material cost instantly reflected in all products/jobs
- Job Estimating page headers make a neat way of doing on-the-spot quotes
- Can't add new components to a description after it has been set up
- Cost of one component can't be dependent on another
- Inflexible design of printed quotes might be inconvenient
- Generally only suited to smallish businesses

### Pocket CalcStar

£39.95 • Davis Rubin Associates • 0386 841181

GOOD VALUE!

A fairly traditional spreadsheet but with a few surprising features. It's not particularly large or fast, but is attractively priced and has all the basic functions. Can form part of an integrated system with the other Pocket products. A safe buy for the first-time user, and the documentation is up to the usual high MicroPro standards.

#### PLUSES • MINUSES

- Good range of mathematical calculation functions.
- Good documentation – sections for beginners and reference.
- You can preset a course of cells to visit, for form filling.
- Can be integrated with other Pocket products, eg ReportStar
- Screen size is very small – at most 15 spreadsheet rows, and normally only 10.
- No auto-recalculate facility
- It's not very fast
- You can't type heading text etc. over adjacent columns

## UTILITIES

### Rotate

£24.95 • Proteus Computing/Trinity Business Systems • 01-748 2302

Rotate is a simple utility program to print out text files rotated through 90 degrees on the paper. This gives you more columns per page which will be needed for some programs, like large spreadsheets.

#### PLUSES • MINUSES

- Simple menu-driven program does just what it says
- Choice of four print fonts, which can be used to print unrotated files too
- The quality is nothing like NLQ (e.g. the ordinary "high quality" print option)
- Only prints plain text, no subscripts, underlining etc.
- No specific support for non-Amstrad printers

### Oxstat

£113.85 • Medstat Ltd • 0602 411120

This is a specialised statistical analysis package for the PCW. Functions from calculations of means to multiple linear regression are covered, and it can do some rudimentary graphics for results. You can read data from spreadsheets or external devices.

#### PLUSES • MINUSES

- Comprehensive range of statistical functions implemented
- Good screen editing facilities for entry of data
- The speed seems acceptable, even though it is written in BASIC
- Even complex analyses are easily entered by simple menus
- Weak on graphical presentation of results

### Landscape

£19.95 • Systembuild • 0778 344388

This is a utility to print out ASCII files rotated on the printer page, so as to make full use of the extra page width. It provides page dimensions of up to 255x96 characters, in a fairly condensed typeface. Runs as a BASIC program.

#### PLUSES • MINUSES

- Readable, condensed draft quality typeface
- Simple and effective to use
- It's an undesirable hassle to have to run it from BASIC
- It's simple, but really needs more than its 200 words of documentation.
- No choice of fonts or text quality.



## BrainStorm

£49.95 • Caxton Software • 01-379 6502

An "ideas processor", *BrainStorm* is a computerised doodling pad. You can jot phrases down randomly, then organise them into a hierarchical plan, then expand each phrase into a finished idea, and finally print them out as a coherent document. If you find it easier to work at a keyboard than with a pencil and paper, this will really help you think.

### PLUSES • MINUSES

- No limit to the number of sub-levels of plan you can have
- You can output the rough text, for a wordprocessor to polish
- Good documentation, including some neat ideas for applications
- Provides a unique service, which should be useful to you
- Needs better graphics (like GEM?) to let you browse the structure easily
- The command keystrokes are unnatural — you can't use the cursor keys to move around the screen
- As a word processor, it is very primitive
- A notepad and a pencil would cost you £1 or less

## Write Hand Man

£29.95 • Hisoft • 0525 718181

This is a program which sits in the background whatever you are doing, and at the press of a command key a menu pops up in a 'window'. For example, if you are word processing, press the key and up pops a calculator, a notepad, a diary. Designed to eliminate paper, but the more advanced functions (notepad) are so cumbersome they fail to be at all useful. Better to buy a £4.95 Casio calculator and a pencil & paper.

### PLUSES • MINUSES

- Results from the calculator can be 'pasted' directly into documents
- You can define the PCW keys to produce whatever strings you want
- Manual is technical and incomprehensible
- Notepad functions are slow and cumbersome to use
- Takes up a lot of disc space and CP/M workspace
- Costs much more than an HB pencil with notepad

## ExBasic

£11.45 • Nabitchi Computing • 051-708 8775

EXCELLENT  
VALUE!

A utility program which augments Mallard BASIC's commands, allowing you to use quite sophisticated graphics functions. You can draw or erase lines, circles or dots, save and load screenfuls of data, pause, beep ... all with commands like **PRINT** ";DRAW.";100;200; Guaranteed no machine code or POKes needed!

### PLUSES • MINUSES

- All functions done by simple BASIC PRINT statements
- No machine code knowledge needed
- Good range of simple drawing commands available
- Can save and load images once you've got them right
- Very cheap!
- Not quite fast enough for proper animations/games programs

## Disc Mate

£24.99 • Siren Software • 061 848 9233

VITAL  
TOOL!

*Disc Mate* is a set of CP/M utility programs which bring complex disc recovery operations within the scope of CP/M novices. Facilities include recovering erased files and making files "read only" (i.e. unerasable).

### PLUSES • MINUSES

- Simple on-screen instructions once you've got started
- Allows easy recovery of accidentally erased files
- "ZIPDISC" program speeds up disc access by 10 to 20%
- Friendly file copying program in case you find CP/M's PIP incomprehensible
- Can read both single and double density discs
- The instruction sheet is very brief, so you'll need to understand CP/M basics

## PlanIt

£24.95 • Database Software • 061-456 8383

Three programs to help you organise yourself. It looks after addresses, expenses, sorts out your personal finances and notes down all important diary dates. It also acts as an interest calculator and a calendar program.

- A lot of program for the money.
- Well designed screen layout and operating system.
- Decent manual.
- Methodical approach needed to use it properly.
- Card Index could be more flexible.

## The VICAR

£29.95 • lansyst • 01-607 5844

A programming tool for serious programmers. If you have a several-hundred line program held in several files on a disc, you can lose track of which variables are used where. The VICAR produces a concordance listing and other diagnostics, to help

you find bugs and maintain the program.

### PLUSES • MINUSES

- Easy to use but still flexible through use of options
- Amstrad versions all at a special low price
- Good manual
- Only of value on large programs
- Limited value to most PCW users (except BASIC buffs)

## SuperType (née FontGem)

£19.95 • Digita International • 03954 5059

USEFUL  
AND FUN!

A program for users of *LocoScript* and CP/M programs, which modifies the fonts (i.e. the look of the characters) used by the PCW printer. *SuperType* has 4 'business' fonts and 4 'novelty' fonts, like *Olde English*. It works by directly altering the .EMS files for *LocoScript* or CP/M, so you only need run it once -- after that, the new chosen font is automatically available.

### PLUSES • MINUSES

- Once installed, you can totally forget it's there
- Genuinely useful range of fonts available
- Works with *LocoScript* as well as CP/M
- All *LocoScript*'s print size and style options still work with *SuperType*
- Doesn't take up any extra disc space
- You can't mix different fonts in the same document
- You have to have different work discs for each font you want to use

## Amstat 1,2,3 and 4

£27.95-£39.95 • GJ & SC Coleman • Ashby-de-la-Zouch LE6 5DA

A suite of four statistical routines including a business analysis program, forecasting and resource management. All four cost £99.95. Sophisticated but perhaps awkward for beginners.

- Good range of statistical functions
- Good manual
- Can produce fair quality graphical results
- Some editing procedures very long-winded
- Needs some expertise to use properly
- Weak on checking that input data is reasonable.

## Grammatik

£49.95 • Optronics • 01-892 8455

This program checks your grammar in the same way that a spell-checker checks your spelling. It also can check for 'sexism' with a list of 'gender specific' terms. It works on a *WordStar* or *LocoScript* file (in ASCII form) and points out real blunders.

- Shows up grammatical problems you never knew you had.
- Marks up existing text for re-editing.
- Lets you build up your own jargon dictionaries.
- Needs to be used intelligently.
- Can't spot errors in context.
- Expensive.

## Companion

£19.95 • Digital Integration • 0276 684959

Background program which provides a calculator, a clock, simple disc maintenance operations, a notepad, a phonebook, and a diary which can be used while using other CP/M programs.

- Can be called up while any CP/M program is running.
- Calculator, clock and disc manager are easy to use.
- Permanent clock keeps good time.
- Good, clear manual.
- Notebook, phonebook and diary are too slow to be useable.
- Notepad functions need to use A drive -- awkward for 8256 owners.
- Doesn't work with *LocoScript*.
- Takes up over 3k of CP/M workspace.

## Loco-Print

£39.95 • Anglo Computers • 0970 4321

For those people who like *LocoScript* but want to use a daisywheel printer. It modifies the *LocoScript* system disc so that every time that disk is used printing is sent direct to the daisywheel. Includes or modifies virtually all the *LocoScript* print commands.

- Can obey most main *LocoScript* layout codes.
- Once set up runs from *LocoScript* 1.2.
- Can use most leading makes of daisywheel printer.
- Doesn't work on *LocoMail* or *LocoSpell* versions.
- Doesn't handle proportional spacing very well.
- You have to reset PCW to use standard printer again.



## THE BBD DUST COVER COLLECTION

Tailored in nylon fabric that has been treated with an anti-static inhibitor. Attractively finished with contrasting piping. Can be washed and ironed.

**PCW 8256/8512 £11.95**

3 piece set in soft grey. Monitor and printer piped in green. AMSTRAD PCW hot foil printed on keyboard.

**PC 1512 £8.50**

2 piece set in ivory coloured nylon. Monitor piped in maroon. AMSTRAD PC hot foil printed on keyboard cover.

**TIMATIC HARD DISC £9.50**

1 piece cover in light grey nylon, piped in green to cover monitor and keyboard. Matching printer covers also available.

### PRINTER COVERS TO MATCH

A range of covers for over 200 printers to match any of the above covers eg. Amstrad 2000 and 3000, Brother, Canon, Citizen, Epson, Mannesmann, Star, Ricoh, Smith-Corona etc. Prices start from £4.50

Please make cheques payable to:  
**BBD DUST COVERS**  
The Standish Centre, Cross Street  
Standish, Wigan WN6 0HQ  
Telephone: 0257 422968



DEALER ENQUIRIES WELCOME

Available in the Southern Hemisphere from TECH-SOFT  
324 Stirling Highway, Claremont 6010  
West Australia. Tel: (09) 385 1885

**LOWEST PRICES GUARANTEED**

**PCW8512 £469 + VAT**

**PCW8256 £375 + VAT**

**PCW 1512**

**PHONE FOR LATEST PRICE**

**ELECTRIC STUDIO MOUSE etc. £99.99**

**LIGHT PEN £59.99 PLUS VAT**

**COMPARE OUR PRICES!**

(EXAMPLES)

**NEWORD (NEWSTAR) 1512/8512 £59.95**

**ABILITY (MIGENT) 1512 £79.95**

**D. BASE II (ASHTON TATE) 8512/6128 £85.95**

**SAE FOR FULL LIST OR PHONE**

**PANASONIC PXU PRINTER £189.50 + VAT**

**GAMES SEND SAE FOR LIST**

**1512 IBM COMPATIBLE MICROSOFT INFOCOM PAPERBACK BORLAND POWER-UP DIGITAL RESEARCH SUBLOGIC & OTHERS ALL UP TO 25% OFF M.R.P.**

**5 1/4 DS/IDD DISCS 100% ERROR FREE FUJI £14.50**

**BULK ORDERS - SCHOOLS, MOD, COLLEGES etc. Please Phone**

**8512/6128 ALL M.R.P. LESS 20%**

**BARGAIN BUYS**

**(0604) 28515/33578 OR FREEPOST RICHARD REEVES LTD. 57 Gold Street, NORTHAMPTON NN1 1BR (Callers welcome)**

Please write order on separate sheet of paper. I enclose cheque/P.O. payable to Richard Reeves Ltd.

# CAPITOL COMPUTER PRODUCTS LTD

HOTLINE 0705 380531

## KUSTOM COVERS

Spectrum £4:95  
Commodore 64 £4:95  
BBC £4:95  
Electron £4:95

### PRINTER COVERS

Amstrad 464 Dustcover Set £7:50  
Amstrad 6128 Dust Cover Set £7:50  
Amstrad 8256 Dustcover Set £9:95  
Amstrad PC1512 Dustcover Set £11:95

DMP 2000 £4:95  
DMP 3000 £4:95  
Amstrad PCW £4:95

### DUST KILLS

## ANAGRAM SYSTEMS ACCOUNTING PRODUCTS

### AMSTRAD PCW 8256/8512

Sales & Nominal Ledger £86:25  
Purchase & Nominal Ledger £86:25  
Stock Control £86:25

### AMSTRAD 1512 IBM COMPATIBLE

Sales & Nominal Ledger £113:85  
Purchase & Nominal Ledger £113:85  
Stock Control £113:85

**Don't rush into accounting with the Amstrad Just make it A-S-A-P**

### AMSTRAD 8256

#### CAXTON

Cardbox £55  
Condor One £95  
Scratch Pad £55  
Touch N Go £22  
Smartkey £45  
Brainstorm £45

#### HISOFT

Devpack 80 £35  
Pascal £35  
C £35  
Knife £12  
Torch £12  
Art in Pascal £12

#### MICRO PRO

Wordstar £45  
Wordstar Deluxe £65

#### COMPACT

Accounts £195  
Day Book £65  
Nucleus £65  
Stock Control £65  
Payroll £65

#### QUEST

Matchbox £25  
Cash Trader £95  
Shoe Box £145  
Time Keeper £65

#### MICROPOWER

Mailflow/Dataflow III £45

#### LINK

Teach Yourself Locoscript £14

### PC1512 & IBM

#### CAXTON

Cardbox £55  
Condor One £95  
Scratch Pad + £55  
Touch N Go £22

#### COMPACT

Accounts £195  
Daybook £85  
Stock Control £85  
Payroll £85

MIGENT Ability £89

### ACCESSORIES

#### EUROMAX

8256 Joystick Interface £13  
8256 Wizard £18

#### DISKS

Box of 10 3CF2 £36:95  
Box of 10 5 1/4 DS/DD £9:95

#### JOYSTICK

Cheetah + 2 £8  
Cheetah Mach 1 £14

### PC GAMES

Crusade in Europe £24  
Conflict in Vietnam £24  
Decision in the Desert £24  
Spitfire Ace £17

F15 Strike Eagle £21  
Silent Service £24  
Solo Flight II £19  
HellcatAce £17

### AMSTRAD 8256

Cambase £49:95  
Payroll £49:95  
Integrated Accounts £149:95

### PC1512 & IBM

Cambase £49:95  
Payroll £49:95  
Financial Manager £149:95

Camssoft Paper, Invoices, Statements, Remittance Advice £34 per 100

Please make Cheques/Postal Orders Payable to:  
**CAPITOL COMPUTER PRODUCTS LIMITED**  
Unit F3 Railway Triangle Farlington Hampshire PO61TG  
**PLEASE SUPPLY THE FOLLOWING**

NAME \_\_\_\_\_  
ADDRESS \_\_\_\_\_  
POSTCODE \_\_\_\_\_  
DAY TELEPHONE NUMBER \_\_\_\_\_  
SIGNED \_\_\_\_\_

Please debit my ACCESS/BARCLAYCARD The value of £ \_\_\_\_\_  
All prices include Vat and Postage in the UK Overseas please add £1:50



DEALER ENQUIRIES WELCOME.



## IT'S BASIC

£7.95 • Nabitchi Computing • 051-708 8775/0123

GOOD VALUE!

Games with a more serious intent. This program provides 20 simple games and applications, and allows programmers to look at the Basic to see how it's done and to adapt it for their own programs. You can play music on your CPM and create your own Space Invader figures.

- Twenty programs at rock bottom price.
- Invaluable tips for programmers.
- Costs little more than a blank disc.
- No tutorial guidance.
- Non-programmers may get bored.

## Pertmaster

£69.00 • Abt Software/NewStar • 0277 220573

Pertmaster is a project planning aid. You specify the events, sequencing and durations of the component tasks of a project, and Pertmaster will analyse the job by Critical Path Analysis. It can detect errors in the plan, produce reports and crude graphical summaries.

### PLUSES • MINUSES

- PERT charts and Critical Path Analysis are established planning methods
- Up to 500 activities may be considered at once
- Plans can be altered to see "what if ..." results
- The PCW isn't really powerful enough to do it justice; it certainly needs a PCW8512
- Screen graphics are very weak; you can't get a graphical overview of the whole network
- It doesn't have simple default settings for a rough-and-ready plan

# EDUCATIONAL

## Iankey Two Fingers to touch typing course

£24.95 • Iansyst • 01-607 0187

IMPROVERS' BEST BUY

Despite its provocative name, a useful typing tutor in that it specifically caters for people who can already get by on keyboards with two fingers. You are gradually introduced to touch typing, so your speed doesn't drop while you learn. Fills a necessary slot in the Typing Tutor market.

### PLUSES • MINUSES

- Suitable for improving two-finger typists without much drop in speed
- Full on-screen instructions
- Exercise text is interesting paragraphs, not letter drills
- Explanation text is annoyingly verbose in some lessons
- It doesn't always ensure that the cursor is properly aligned with the exercise text

## Iankey Crash Course

£24.95 • Iansyst • 01-607 0187

A fairly traditional typing tutor, taking you through basic keyboard exercises. There's a lot of explanatory text, which gets in the way second time around. Definitely competent, but a bit boring.

### PLUSES • MINUSES

- Mostly avoids boring letter drills
- Very full on-screen information guides you along
- "Fast" option cuts out some text if it gets repetitive
- Unimaginative use of graphics, compared to Computer One's tutor.
- It doesn't always ensure that the cursor is properly aligned with the exercise text

## Touch 'n' Go

£24.95 • Caxton Software • 01-379 6502

A very traditional typing tutor, with no attempt at interesting screen presentation. Letter drills are rigorously pursued, making for good typing practice if you can stick to it. Also has number keypad tuition for data entry operations.

### PLUSES • MINUSES

- Methodical letter drills enforce good practice.
- Provides number keypad tuition as well as letters.
- Instruction screens are optional, so can be cut out for speed.
- Gives a flattering error rate, since it allows you unlimited use of the delete key.
- Doesn't tell you how to make the number keypad actually work on the PCW!
- Boring use of the screen. You need to really want to learn.

## Micro Maths

£24.95 • LCL • 0491 579345

WELL DESIGNED

Supposedly covering 8 to adult ages, this seems an O-level type program, covering topics from calculus to tables. A good implementation on the PCW with proper use of the screen. Questions are picked at random from a pool, so may repeat but never run out. Replies to questions are typed in mathematical notation, like  $X^2+3$

### PLUSES • MINUSES

- You can pause to use BASIC as a calculator while you think
- 'Unlimited' question set
- Comes with a 'free' book of AEB O-level questions
- Good hints and explanations when you get an answer wrong
- Questions in a topic repeat occasionally
- Some frills, like the clock and beeper, are annoying
- No flexibility to add questions for a particular syllabus

## Chemistry • Biology

£12.95 • School Software • 010 353 61 27994

These two are fairly traditional question-and-answer tests. You are faced with a choice of 10 topics, and then asked 10 or so questions each, where you have to fill in the blank in a statement. There are preamble notes beforehand, and if you get it wrong you are given a clue. Aimed at 12-16 year olds.

### PLUSES • MINUSES

- High standard of questions for O-level students
- Preamble notes introduce topics
- The fill-in-the blank questioning style has little flexibility for different answers
- No option to add questions for a specialised syllabus
- Screen Chemistry formulae are difficult to read

## Better Spelling

£12.95 • School Software Ltd • 010 353 61 27994

This is a spelling course aimed at the 8 to adult age group. It consists of a series of well organised, short lessons each dealing with one topic, like plurals or which version of there/their/they're to use in a sentence. The use of the PCW screen is rather unimaginative, and doesn't hold your attention.

### PLUSES • MINUSES

- Well thought out lessons to emphasise particular points
- Teaches words in a sentence context as well as in isolation
- Lessons can be picked in any order from a menu
- Seems to be proof against mischievous key pressing
- Boring use of the screen doesn't grab interest
- No instructions come as to how to use the program.

## Animal Vegetable Mineral • World Wise

£14.95 each • Bourne Educational • 0794 523301

Aimed at the younger market, 7-15 year olds. Both these programs work by learning as the child uses them. Think of an object and the computer tries to guess it. If it is wrong, the child is asked for a question which would allow the PCW to be right next time, and it learns.

### PLUSES • MINUSES

- Can be used as many times as the child's imagination holds out
- Performance can be analysed by a teacher after a session
- As you build up a base of objects and questions, they can be saved for reuse
- It needs a lot of typing, hence a lot of supervision
- The PCW starts with only two objects known, so it takes time to get going
- Documentation has hardly been altered from cassette-based versions
- Since it is for young children, more imaginative use of the screen would be nice

## NEXT MONTH

The guide continues next month with the categories of WORD PROCESSORS (including spelling checkers and mail mergers), GAMES and ACCOUNTS (including payrolls). The month after will cover DATABASES, COMMUNICATIONS and GRAPHICS, and the month after that it's back to this month's topics.

Our intention is to keep publishing the three parts of the guide in rotation, updating it each month to include all new products. If you would like to see other sections of the guide, back issues of 8000 Plus are available at £1.50 each.

Meanwhile, if you are aware of any significant omissions or errors in the File as published, please let us know. We intend to maintain it as THE authoritative guide to PCW software.



# The UPGRADE

★ SPECIAL OFFER TO PCW 8256 OWNERS ★

Thought about upgrading to PCW 8512 specification?  
Wondered if you could manage to do this yourself?

**NOW YOU CAN FIND OUT.**

Send us £1 and we will send you a copy of our INSTALLATION INSTRUCTIONS and our FACTSHEET on upgrading. You may deduct the £1 when you order your upgrade.

The specialist PCW magazine, "8000 Plus" selected our Upgrades as "BEST VALUE D-I-Y MEMORY UPGRADE" and "BEST VALUE 3 INCH SECOND DRIVE"

"Silicon City instructions are clear and concise...you could find it easier than you think".

The simplest, most comprehensive step-by-step instructions available assume no prior knowledge, experience, or skill. We supply tested, TOP QUALITY, fast (150nS) chips which are jig preformed for ease of insertion — NO BENDING REQUIRED — plus a spare 'practice' chip to give you confidence.

Our "Best Value" Upgrade Kit is NOW ONLY **£23.90**

\*If you go a stage further and add a second disc drive, you won't need to swap discs at all.\*

"Fitting the second drive is simple enough...Everything other than the drive is already there in your machine: the cables are ready wired and both LocoScript and CP/M software will recognise it automatically once it's fitted...you'll have to try pretty hard to get it wrong.."

Internal PCW 8256 DS/DD Second Disc Drive  
1 Megabyte unformatted (720K formatted)

**£135**

Memory Upgrade plus Second Disc Drive

**£155**

Supplied with simple, comprehensive fitting instructions. NB You will require CP/M version 1.2, or later to format high density discs. Amstrad will exchange earlier versions free of charge.

TRADE ENQUIRIES WELCOME

Prices INCLUDE VAT and UK post, normally by return.

Send UK Cheques/Money Orders/LA or Government orders to:

**SILICON CITY**

Dept. 8, Mithian, St. Agnes, Cornwall TR5 0QE

Access/Visa orders: Telephone 087 255 2112

## AMSTAT

MODULAR STATISTICS AND MATHEMATICS PACKAGE

Marketed by

**S.C. COLEMAN**

Available for BOTH PCW AND CPC ranges

★★★★ NEW AMSTAT7 ★★★★★

**AMSTAT1 (V1.2)** — means, st. devs., variance, skew, kurtosis, 1-sample, 2-sample, and paired t-tests, 1-way-AOV with single and mult. conf. intervals, 2-way-AOV, correlns, regression, histograms, scattergrams, transformations, file store and retrieve, output to WP file, manual. Flexible variables and observations to a total of 500 (+) data points.

**AMSTAT2** — 27 nonparametric tests in 4 programs providing a "complete Siegel". Binomial, Chisquare(3), Kolmogorov-Smirnov(2), Runs, McNemar, Sign, Wilcoxon, Walsh, Randomisation(2),

Fisher, Median(+extension), Mann-Whitney, Wald-Wolfowitz, Moses, Cochran, Friedman, Kruskal-Wallis, Contingency, Spearman, Kendall, Kendall partial, Concordance.

"tremendous value" — Tony Kettle, Popular Computing Weekly, 8-14th May 1986

"I now give it an unreserved recommendation..." Jo Stork, Business Computing with the Amstrad, July 1986

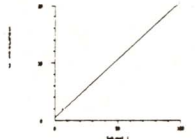
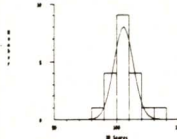

**AMSTAT3: FORECASTING**

An array of business oriented mathematical and statistical software: Linear and Polynomial regression, Trend and Seasonal Variation, Multiple Regression Analysis, Transformations, Exponential Smoothing, Adaptive Filtering. Graphic display, full printout, manual suited to immediate use and for teaching.

**AMSTAT4: RESOURCE MANAGEMENT — LINEAR PROGRAMMING MODULE**

General purpose Linear programming + Specialised Transportation and Assignment variants. Capable of analysing and solving problems of sequencing, scheduling, blending, and allocation of scarce resources. 40 page manual, 18 worked examples.

**AMSTAT6: SFANOVA** — Up to 8-way analysis of variance for equal cell sizes. Unequal cell sizes on 1-way AOV. Maximum of 2000 data points (300 on unexpanded CP/M 2.2). Input from ASCII Files. Output to screen or text file with full AOV table + main and interaction means and Newman-Keuls on main effects. Manual. (Disc only.)

**AMSTAT7: RESOURCE MANAGEMENT II — STOCK AND PRODUCTION ANALYSIS**  
Calculation of optimum re-order levels for both single and multiple items. Dynamic programming to calculate optimum production schedules for single items and consolidation of several results into a multiple schedule. Also Pareto and Lorenz analysis. Output to screen or printer. Includes operational manual with worked examples.

The programs have applications in research of all kinds, education, sales, production planning, work and method study, financial planning, personnel, social work etc.

Price list:	CPC	PCW	Price list:	CPC	PCW
AMSTAT1 v1.2	£25.95	£27.95	AMSTAT6	£25.95	£27.95
AMSTAT2 v1.0	£39.95	39.95	AMSTAT7	£25.95	£27.95
AMSTAT3	£25.95	£27.95	AMSTAT1+2	£49.95	£49.95
AMSTAT4	£25.95	£27.95	AMSTAT1+2+3+4	£99.95	£99.95

All prices include P&P within U.K.



+ 24 hours answerphone.

Cheques POs to

**S.C. Coleman, 33 Leister Road, Ashby-de-la-Zouch, Leics. LE6 5DA Telephone: 0530 415919**

### PAYROLL PROBLEMS?

Does your payroll cope with the forthcoming changes: NI & SMP?

Be ready for 6th April 1987 — Buy  
**CHERRY PAY**  
NOW



**CHERRY  
MICROS**  
109 High Street  
Lochee  
Dundee DD2 3BX  
Telephone (0382) 610472

**ONLY**  
**£69.99**  
incl. VAT

# MicroSkil

Training for

**AMSTRAD  
PCW's and PC's**

Can't understand the manual?

Are they 'barmy' or is it me?



If you're a first time user on the Amstrad PCW series or the new PC, have a word with us and we can train you on how to use your new computer.

We can help you perform the fine arts of word processing, from basic to advanced levels or to gain a knowledge of computerised accounts.

If you are interested in any of these courses phone Colleen for more details.

**Unit 12 The Micro Centre 0734 755768  
Gillette Way, Reading  
Berks, RG2 0LR**



# 8000 PLUS

# TIPOFFS

## The collection: issues 1-5

### A PEAK AT THE CONTENTS On LocoScript

Major articles on Headers and Footers, Tabs and Rulers, Producing Tables, and Laying out Business Letters. Plus scores of tipoffs: Overprinting, Foreign characters, Creating a letterhead, Better Underlining, Typing ahead, Speeding up Long Documents, Using Phrases, Mathematical symbols, Two-column printing, and numerous others.

### On CP/M

Major articles on Disc-Handling (including how to make an auto-start disc), Customising individual keys, Controlling the Printer, RPED, SETSIO and DEVICE. Plus tipoffs on using PIP, function keys, screen printouts, SETKEYS, avoiding problems with DISCKIT, and many more.

### Other TipOffs

Feeding Continuous paper, Label printing, Using A5 paper, Ribbon re-inking, Screen contrast, the free game of Life on your master discs, Boot discs for Cracker and NewWord, and a host of slick little tips for Basic programmers. To mention but a few.

At last the publication you've been clamouring for is here. We've put under a single cover the complete range of TipOffs published in the first five 8000 Plus issues. And there's more: the series of (so we're told) outstanding tutorial articles on LocoScript and CP/M reprinted from those issues.

To tie the whole package together is, published for the first time, a comprehensive index. So now at last you can turn instantly to the information you *know* we published somewhere but can't remember where.

So much material was covered in the first five issues of 8000 Plus this compilation is certain to become a constantly used reference book. Apart from anything else, it offers a chance to catch up on the bumper tips section in sold-out issue 2. *The 8000 Plus Tipoffs Collection* is printed on high-quality paper with a colour cover and we think it deserves a permanent place next to your PCW.

SPECIAL OFFERS  
SPECIAL OFFERS  
SPECIAL OFFERS

8000 PLUS  
TIPOFFS  
The collection: issues 1-5

**FREE!**

when you take out a subscription. Or buy it separately for £4.95. (The price for existing subscribers is just £1.95)

Complete with index!

### Why You Should Subscribe to 8000 Plus

It costs just £17.95 to take out a 12-month subscription to 8000 Plus. There's several reasons why it makes sense to do so, quite apart from the attraction of the free TipOffs book offered here.

- You're *guaranteed* a copy each month, delivered hot off the press direct to your door. (Many newsagents are selling out within days of publication.)
- You're *protected* against any future price rises.
- You're *entitled* to lower prices on some reader offers.
- You're *supporting* the magazine in the most effective way.



## COMPUTER SCRABBLE

Only £17.95 - save £2!

Writers, wordsmiths, LocoScript users all, this is the program you've been waiting for.

The much-loved, much-played word game has arrived on the PCW courtesy of Leisure Genius, and presents you with a new challenge: Can you beat your word-processor at word processing?

Be warned, the program, backed up by a huge built-in vocabulary, plays a very mean game. It knows all the rules and will use every trick in the book to build up mind-boggling scores.

The full Scrabble board is displayed on screen with all the squares in their usual places. More than one player can take on the computer, and you can set the program's level from super-fast to super-smart. There are plenty of other options, including the facility to watch the program 'think'.

If you bought your PCW for word processing, what are you waiting for?

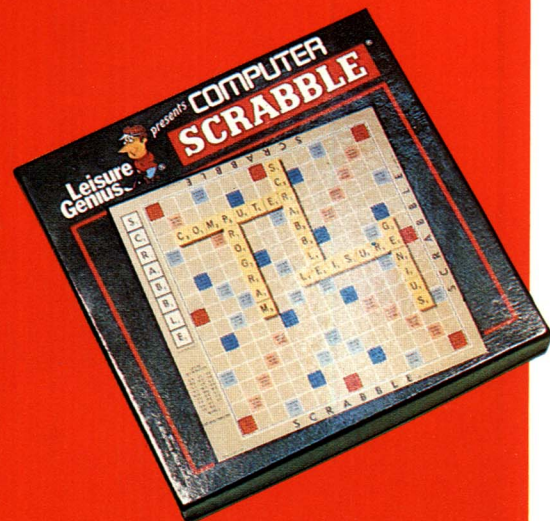



# 8000 PLUS DUST COVERS

Just £11.95 for the complete set

Ever wondered why you see so many computers dust covers advertised? It's because computers don't like dust. Over a period of time it can make them very ill indeed: keyboards stick, disk drives become less reliable, printers smudge.

A set of dust-covers for the three parts of your system provides a neat solution. And there's the added bonus of smartening up the hardware's appearance when it's not in use.

The specially-commissioned 8000 Plus covers are made from high-quality anti-static nylon fabric. The covers themselves are a soft grey colour with those for the monitor and printer piped in red.

The keyboard cover bears the 8000 Plus logo in red.

It adds up to a good argument for a cover up.



# BINDERS

Just £4.95

Here's the cure for a desk cluttered with back issues of 8000 Plus: the official 8000 Plus binder.

It's a smart, sturdy piece of kit with our logo stamped proudly on the spine. More to the point, it holds 12 copies of your favourite magazine and is guaranteed to keep them in fine condition for years to come.

Loyal readers, roll up.

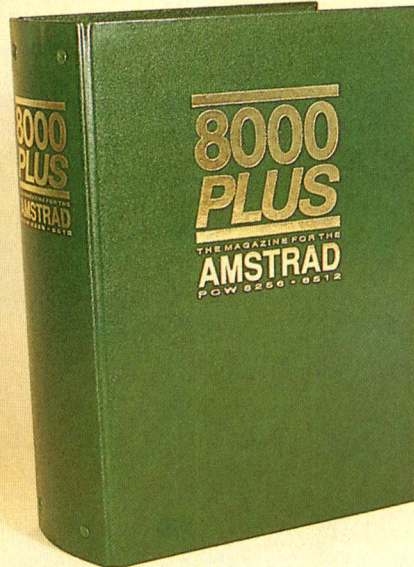

## HOW TO ORDER

Just fill in the  
form overleaf ▶

## SPECIAL OFFERS WANT A THINGI?

Yours for just £5.95 – save £2!

What's white, dangles papers next to your computer screen, and costs two pounds less than in the shops? Yes, a Thingi bought through 8000 Plus.

This remarkable computer accessory – an idea so simple it's ingenious – could dramatically ease your word-processing hours. All it is is a cleverly shaped piece of plastic that attaches via Velcro to the top of your micro. But with a Thingi on your PCW you can have documents, letters, or program listings clipped right next to the screen in perfect reading position.

Any task involving copying off paper is thereby made much easier and faster. In fact the clip supplied is sturdy enough to support an issue of 8000 Plus open, say, at the TipOffs section.

The Thingi can be positioned either to the left or right of the screen and can easily be removed and replaced if necessary.

A really sensible, cost-effective add-on for your PCW.

SPECIAL OFFERS  
SPECIAL OFFERS

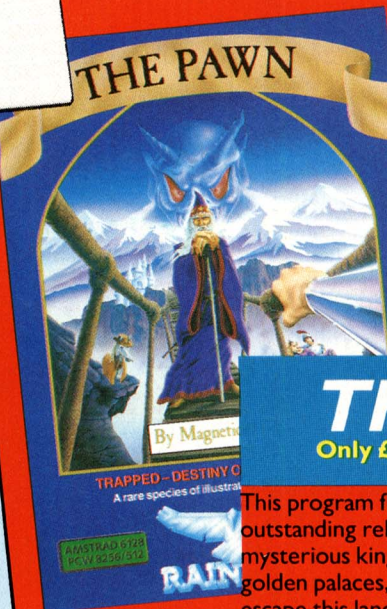

## THE PAWN

Only £19.95 – save £5!!

This program from Rainbird Software is one of the year's outstanding releases. It's a grand adventure set in the mysterious kingdom of Kerovnia replete with ice towers, golden palaces, dangerous forests. In your battle to escape this land you encounter intriguing characters such as the laughing Buddhist monk, and must use your sharpest wits to extricate yourself from some dire situations.

Where the game excels is that it features both outstanding graphics and effective text description and interaction. The 8000 Plus reviewer awarded it five out of five across the board, so what could we do but rush out and obtain it at a discount for you our readers...? A magical purchase.



**ACCESS / VISA HOTLINE**  
If you prefer to telephone your order,  
just dial 0458 74011 and ask for credit  
card orders.

# HOW TO ORDER

Just fill in the form  
on left of page

## ORDER FORM No.7

Use this form to order either a subscription or special offers by ticking the items you require. If you want both a subscription AND special offers you must fill in your name and address in BOTH parts of the form as these will be separated by us.

### SPECIAL OFFER SECTION

Name \_\_\_\_\_

Address \_\_\_\_\_

Post code \_\_\_\_\_

### CAXTON SOFTWARE OFFER

Prices include two free blank discs.

- Condor 1 £87.50
- Brainstorm £43.75
- Cardbox £49.95
- Scratchpad Plus £49.95
- Touch'n'Go £19.95

Tick up to three extra gifts if entitled.

- Mastering the 8256/8512
- Batman  Dust cover set

- SCRABBLE £17.95
- THINGI £5.95
- DUST COVER SET £11.95
- BINDER £4.95
- TOMAHAWK £17.95
- DK'tr'nics SOUND UNIT £29.95
- SUPERTYPE £16.95

### INFOCOM GAMES £19.95

- Hitchhiker's  W'bringer  Ballyhoo
- Zork I  Zork II  Zork III
- Enchanter  Spellbreaker
- Sorcerer  Leather Goddesses
- Suspended  Planetfall
- Seastalker  Deadline

### SUBSCRIPTION SECTION

Name \_\_\_\_\_

Address \_\_\_\_\_

Post code \_\_\_\_\_

- 12-mth-SUB. £17.95 (inc binder)

Your sub will start with April issue only if we receive this order rby Feb 28th.

### PAYMENT DETAILS

Value of total order £ \_\_\_\_\_

Payment is by (please circle)  
Cheque • PO • Access • Visa  
Make payable to FUTURE PUBLISHING LTD.

Your credit card number is \_\_\_\_\_

Expiry date \_\_\_\_\_

Send this form plus payment to  
SPECIAL OFFERS • 8000 PLUS  
SOMERTON • SOMERSET • TA11 7PY

# SOUND CONTROLLER

Now only £29.95 – save £10!! Includes programmable joystick interface. Superb value.

Beep, beep, move over. A new era in PCW sound production is here. This delightful little widget from widget pro's DK'Tronics will allow your Amstrad to produce glorious three-channel sound over eight octaves!

Using the same chip that's fitted to the Amstrad CPC computers, it offers the power of producing all manner of sound effects, with full control of tone, volume and 'envelope shape' on all three channels.

Also built in is a standard joystick port – its programmable interface can emulate any set of five keys used in a game, say, for left, right, up, down and fire. The unit itself plugs straight into your PCW expansion port.

Sounds good? It will.

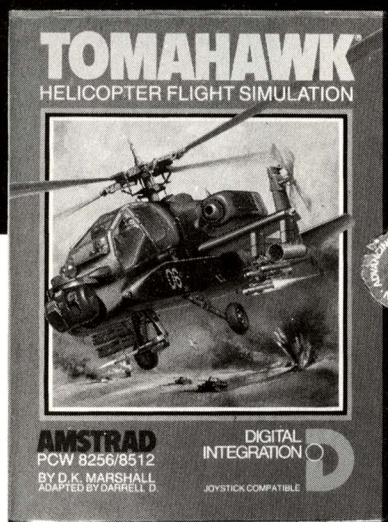
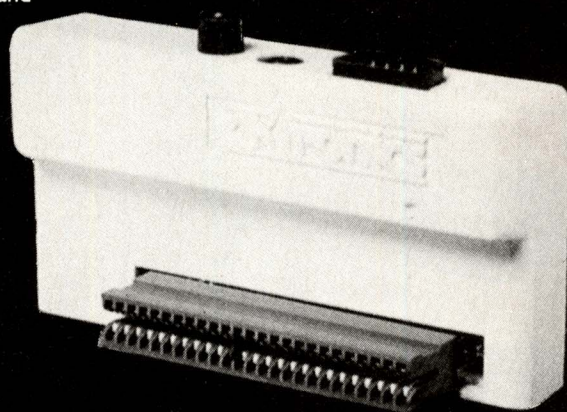

# TOMAHAWK

Only £17.95 – save £2!

This program is a superb buy, both as an impressively life-like simulation of helicopter flight and as a challenging piece of entertainment. It gives you a pilot's eye view, including a detailed instrument panel and a 3D display of scenery outside such as trees, mountains and enemy forces. You engage the latter in combat using three different weapon systems.

Try it and be amazed at what your PCW is capable of.

# SUPERTYPE

Only £16.95 – save £3!

This is the program that was known as *Fontgem* until its marketing was transferred recently from Gemini to Digita. Whatever the name, the software is gorgeous.

What it does is to offer you EIGHT new, radically different typefaces. And each of them has its own distinctive, professional appeal, giving your documents an original facelift.

So, if you want your printed output to look a bit different from all the other LocoScripted letters around, SuperType is what you need. The ingenious thing about the program is that once you've installed your favourite font on a disc, you won't even notice the program working. You can run LocoScript in the normal way and everything will be the same except that when you print out, the results are exciting. The software is compatible with CP/M too.

Great value at its full recommended retail price of £19.95, at just £16.95 it's another remarkable bargain from 8000 Plus.

This is Business 1 font  
This is Business 2 font  
**This is Business 3 font**  
THIS IS BUSINESS 4 FONT  
This is Outline font  
**This is Vaudeville font**  
This is Olde English font  
**This is Stencil font**



SPECIAL OFFERS  
SPECIAL OFFERS

# INFOCOM GAMES

Massive savings on the most sophisticated entertainment software you can buy!

By popular request, here's another chance to buy our favourites from the remarkable range of Infocom adventures at remarkable 8000 Plus prices.

For many people, these programs represent the pinnacle of computer entertainment. What they offer you is NOT graphics or chase-a-blob arcade action. Instead you will find yourself placed in a fictitious world, described in superbly atmospheric detail, and face a sequence of brain-twisting challenges liable to keep you at the keyboard for months.

You communicate with the computer by typing in simple English sentences. If the program doesn't understand, it'll tell you, but the Infocom titles are renowned for their sophistication in handling language, and you'll soon almost believe you're communicating with an intelligent being. In fact, Infocom themselves describe these programs as 'interactive fiction' – it's like finding yourself inside a novel and having the chance of determining your own destiny.

Until recently these programs were not available in the UK for under £30. And for good reason. For one thing, the programs are massive, containing literally tens of thousands of words of description. For another, they're superbly packaged with all kinds of amusing little extras to accompany the comprehensive and witty documentation.

So to be able to pick them up through us for under £20 a piece is simply remarkable. Pull the curtains, shut out the winter and let your PCW transport you into a different world...

ONLY  
£19.95  
EACH – SAVE AT  
LEAST £5!!

## HITCH-HIKER'S GUIDE TO THE GALAXY

Only £19.95 – save £5!

Arguably the world's wittiest, wackiest adventure game. You take on the famous role of Arthur Dent who only stays alive by discovering ingenious solutions to problems such as that posed by the terrifying Bugblatter Beast, a creature so stupid it thinks that if you can't see it, it can't see you.

Can you work out what to do with a pile of junk mail? Can you learn to understand Vagan poetry? Can you show an obstinate door a sign of intelligence? A game to delight and challenge you for months.

## BALLYHOO

Only £19.95 – save £5!

This one's set in a seedy circus in which you have to discover who has kidnapped the owner's daughter. It's packed from start to finish with puzzles of mind-boggling challenge. How do you get a helium balloon that's only reachable across a tight-rope? How do you soothe a gorilla with music when your radio seems incapable of clear reception? How do you trick a clown into letting you past his wagon door?

There are clues cleverly hidden in the accompanying documentation, but even with their help you'll be in for some long evenings!

## WISHBRINGER

Only £19.95 – save £5!

A stunningly atmospheric game in the Infocom fantasy tradition. The action starts with you, the village postman of Festeron, discovering that a cat belonging to the keeper of the Magicke Shoppe has strangely disappeared. Your only help in solving what rapidly becomes a deep mystery is Wishbringer, a small stone bestowing seven special powers.

This program is especially suitable for people embarking on their first adventure. (It's also, however, been raved over by experts!)

We don't have space to tell you about the rest in detail, except to say they're all SUPERB!

## ZORK I

The one that started it all.

## ZORK II

A great follow up.

## ZORK III

The hardest of the series.

## ENCHANTER

Introductory level classic adventure.

## SPELLBREAKER

Sequel to Enchanter. Harder.

## SORCEROR

Sequel to Spellbreaker. Experts only.

## LEATHER GODDESSES

Saucy, sophisticated romp.

## SUSPENDED

Wake up as a robot! Spooky packaging!

## PLANETFALL

Danger on a hijacked spaceship

## SEASTALKER

Rescue on board a sub. Good first buy.

## DEADLINE

Can you solve the murder in time?

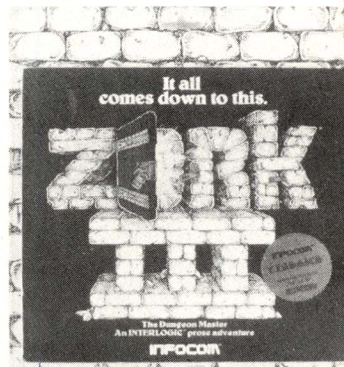
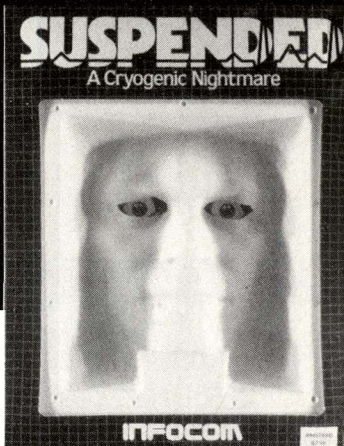
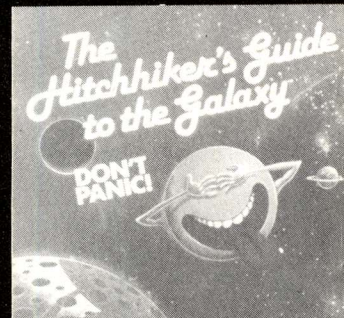



# POSTSCRIPT

Your letters looked at, laundered and listed by a lonesome Ed.

**This month's postbag has been as lively as ever – plenty of contentious views, bouquets, pleas for help, and an occasional criticism, constructive of course. It's what you write that helps us fine-tune each issue to be even better than the last, so get writing! Try us out with your questions, problems, opinions and oddities at: *PostScript*, 8000 Plus, The Old Barn, Somerton, Somerset TA11 7PY. Sorry, but no personal replies.**

**If you are plugged in to the world of comms, you can send us your letter by Telecom Gold, using the mailbox 84:TXT152.**

## Anxious driver

I have a PCW 8512, and read the article on page 10 of the March 1987 issue of the magazine wondering whether and where an additional (third!!) drive can be fitted to my machine.

Is it possible to add a 5¼" drive to the 8512, as the possibility of using such discs on the PCW is pretty exciting? What would be the problems in fitting such a drive to the 8512? Would it show up as a third drive, or would it be attached through the A drive? Is the A-face from Silicon systems the only possibility of a 5¼" drive available for the 8512 at present? And is it available yet?

I have recently produced the magazine for my College using Locoscript, and compliments have come flooding in – the last one was done using an Apple Macintosh desktop publishing system, but everybody says the latest (LocoScripted) edition is better!

**Nicholas J Leach  
Walsall, W Mids**

*As far as I know, the A-face is the only way to add a third floppy disc to an 8512. Your 5¼" drive would be installed alongside your A drive, and you can choose with a switch whether to use it or the standard 3" one. You can't use both at the same time, so you don't really have three drives. Your normal B drive works as usual. As to availability,*

*Silicon Systems claim it will be on sale by the time you read this.*

*As for the PCW vs. Macintosh, you'd better write to Alan Sugar and tell him to not to bother with his high quality printer range!*

## Sorting things out

I have Prospell and SuperCalc2, which, together with the various hints, tips and helpful articles regarding Basic and disc utilities which have appeared in your excellent magazine from issue 1, enable me to do most things I require. Except for one function – I cannot find a way to sort a simple list of words into alphabetical order, which I can then use in LocoScript.

The only sorting facility I seem to have is the 'Arrange' command in SC2, but if I use this I cannot then convert it to ASCII for inclusion into a LocoScript document...or can I?

**Bob Jury  
Guildford, Surrey**

*SuperCalc can save things in ASCII. Once you've Arranged them, use the /O command as you would for printing, but choose the 'Disk file' rather than 'Printer' option. You can also read ASCII files into SuperCalc, although it's tedious ... see this month's two SuperCalc pages.*

## Protex under fire

In view of all the claims made by its colourful double-page advertisements, I decided last November to buy the Protex word-processor for my Joyce. They kept me waiting a month, but at last they sent it. I have had nothing but trouble with it ever since, so it was with interest that I read your review of it in the February issue.

Is the author reviewing a different beast from the one I have? He makes no mention of bugs, so I must assume that either he was sent a different version from mine (v1.95) or he hasn't tried it out properly.

Arnor admitted the bugs but claimed that issuing imperfect new programs "is the only way to find out if a program works". They promised me a version 1.99 if I would send back my disc.

**Terry Dwyer  
Quorn, Loughborough**

*The version we reviewed was indeed the pre-release version 1.95. Our reviewer did find several bugs, but we were assured by Arnor that in the final version of Protex these would have been*

*cured. There seemed little point mentioning them since readers would, in theory, never have seen them.*

*In the event, because of unexpected delays in finishing the product, Arnor sent out this pre-release version to customers who had been waiting a long time. The understanding was that it would be upgraded free of charge when the full version came out.*

*Arnor's David Fisk assures readers that version 2.03, the 'real' Protex, should now be with you, and is every bit as good as our review said.*

## Improved LocoSpell?

I have purchased Locospell and am reasonably satisfied. However I am surprised that no reviews have picked up its most infuriating habit. The program locates my dyslexic efforts with ease, and usually I can recognise the error without having to wait for the suggested replacement word. However I have to sit there powerless for anything up to 15 seconds waiting for the replacement to show its ugly face. Pounding away on the 'E' key has no effect, there is alas no facility to cut out the search for the replacement.

A letter to Locomotive Systems produced a commendably prompt reply (handwritten!) suggesting they are working on it. Alas they were not prepared to wear my other suggestion that the program should 'beep' when finding an error. I do like to get on with other jobs whilst setting the spellchecker into action and cannot do this if I have to keep watching the screen. Come on you other users, swamp Locomotive with letters supporting me. Or am I in a minority?

**Ken Dunn  
Southampton**

*Ugh. I'm dead against LocoSpell beeping when it finds a mistake,*

## Hitch-hiker hitch

Is there any way of tidying up the printout of Hitchhikers Guide to the Galaxy. The screen layout is wider than the printout resulting in extra line feeds being inserted part way through lines and sometimes words. Also why can you not input more than one line of text, when the Guide manual states two lines of text on the PCW?

Finally, a quick tip for fellow Hikers. After quitting the game and going back to the A> prompt, put your 'saves' disc in. Do a DIR and then a screen dump. Keep the printout with your disc for a

permanent reminder of the named saves. It's surprising how often you find you want to go back and undo an earlier action, or pick up something you dropped (such as Junk Mail!)

**Gareth R Price  
Lowestoft, Suffolk**

*It seems you missed our announcement in a previous issue's 'Keywords' page. Contrary to Infocom's instructions, do not run the game with the command 'HITCHHIK', but instead type 'SUBMIT PROFILE'. This will set the screen to the correct size, and then run the game. Hopefully your*



given the number I make! If that's really what you want, then every time you finish a correction and LocoSpell starts its work again, press the 'z' key. When LocoSpell next pauses, it will beep because it doesn't understand that key.

**Print and be damned**

On the subject of printers: I've recently bought a centronics interface and hooked up the PCW to a Brother daisy-wheel typewriter. Thanks to your article in the February issue, I succeeded in making it work: the result, though slow, is of excellent quality.

But there's one problem: when printing out ASCII files (converted from LocoScript), the machines suffer from the curious delusion that they are dealing with continuous paper. I can pause the printing manually at the end of the page by switching the printer off-line (at precisely the right moment). Is there any way to do this automatically?

Has anyone else cracked the secret identity of the people behind 8000 Plus? The clue lies in Richmal Crompton's William books, which concern the doings of the Outlaws, an engaging quartet of juvenile delinquents. The Outlaws' headquarters is the Old Barn. Honest. Now we know what Outlaws do when they grow up.

**A J R Taylor  
Coleford, Glos**

You should find the CP/M command PAPER 11, D works a treat for A4 single sheet paper.

And damn! We've been found out. I'll thcweam and I'll thcweam until I'm thick, as Violet Elizabeth would say.

**BASIC buff**

I am just discovering BASIC, and find your articles and listings wonderfully useful – but it's really frustrating to have to wait a month

before getting the next dose. Short of begging you to come out weekly, can I ask you to recommend a handbook on Mallard BASIC? I was supplied the Amstrad handbook but don't find it particularly helpful, and can't find anything suitable in any bookshop.

Lastly, the entire family and I are all great Archers fans, and have been trying to get hold of the eponymous and extremely elusive game. Noticing that it is apparently distributed by WHS Distributors, I went into my local W H Smith's, who denied all knowledge of it and insisted that their software distribution department had been closed for TWO years. So where are the Archers to be found?

Thank you for a splendid magazine. We only wish it did come out weekly.

**Kate Brown (and the entire family)  
London, SW2**

For BASIC, you could try Ian Sinclair's 'Program Your PCW!', published by Glentop.

The Archers actually is available from W.H Smith's at £13.00, even if they don't know it. I have spoken to WHS Distributors (who do believe themselves that they exist) and I suggest that you go in again and stamp your foot with rage.

Publish 8000 Plus weekly? Writing one a month is quite enough for us. Pass the valium, Alice!

**Attention SuperType users**

Re your article February issue 'Tipoffs'. Although I must congratulate your reader, I must point out that we have discovered after careful testing that the recommendation is not 100% reliable and can cause irregularities to printed output (eg no right justification).

**Jeremy Rihll  
Digita International**

other problem will go away too. Incidentally, this same advice applies to most Infocom games – run them all with 'SUBMIT PROFILE' if they look wrong.

**Spaced out**

Are there any Adventurers out there who know how to catch the damned Babel Fish ("Hitchhikers Guide to the Galaxy")? If the dreaded Vogons throw me and Ford into the vacuum of space once more I'll go bonkers (tried panicking but it don't do no good!). Please send an SOS before I run

out of tea bags.  
**Paul Barrey  
Brighton, Sussex**

Well ... I'm not sure I want to spoil people's fun by giving the whole answer, so here are some hints. If you don't want to know them, put on your peril-sensitive sunglasses now.

The fish keeps falling down holes or being caught by an upper-half-of-the-room-cleaning-robot, right? Well you have to block up the holes with things you are carrying, and remember that the cleaning robot can't pick up more than one thing at once. 'Nuff said?

**Loco crazy**

Locospell is, truly, a wonderful thing. For those of us who have trouble with spelling or typing words like "antidisestablishmentarianism" or "cat". When it discovers a word that is not in its enormous dictionary it will cogitate, sometimes for many seconds, before kindly coming up with a "Suggested Replacement".

I can do no better than submit this story, first in its shamefully uncorrected form, riddled as it is with errors, and finally in all the perfection of the LocoSpell/Longman approved version.

Looking at his diskette where it rested on his paunch he recalled all the filenames on it and thought of Charlotte, his hormones in a turmoil. Had it not been for David Endicott, who had called the constable to deal with the nutters, the faceless crowds in the courtroom would never have convicted Ronald Bevan. The judge, in his summing up, had commented upon the invisibility of the seductress from Rothersthorpe, referred to the "Alas, Poor Yorick" speech and awarded custody of the parmesan cheese to the Barcelonian man.

Looking at his discrete where it rested on his parch he recalled all the fiances on it and thought of Charlatan, his horizons in a turmoil. Had it not been for Davit Enact, who had called the consumable to deal the numbers, the facades crowds in the courthouse would never have convicted Road Bean. The judge, in his sucking up, had commented upon the invincibility of the seamstress from Rotovator, referred to the "Alas, Poor Yoking" speech and awarded custody of the partisan cheese to the Babylonian man.

**P J Townsend  
West Kirby, Wirral**

OK, I give up. Which is the original and which the LocoSpelled version?

**A note and a note**

I have a Casiotone CT-6000 electronic keyboard. It is programmable. I can enter a succession of chords, apply a rhythm and instrumentation, and play it back as an accompaniment for my music practice.

If I switch off, the chord memory is lost. Casio say that by using a MIDI (musical instrument digital interface) between the Casiotone and a computer, I can record the chord memory permanently, and, later, return it to the keyboard's memory. Unfortunately, I cannot use my PCW in this way.

Is it possible to link my two pieces of equipment with some other interface? The IN and OUT MIDI sockets are both five-pin DIN. I bought each instrument separately because it was the most suitable one for its particular purpose.

More seriously, I think that it would make for more comfortable reading if you used a Roman type face, which is easier on the eyes – especially my tired old ones – instead of Sans, use of which is a modern twee affectation.

**S H Scott  
Watford, Herts**

Electromusic Research (0702 335747) are planning a Midi interface for the PCW, which should be out by now. We hope to review it next issue.

As for your final comment, well!

Did you see our issue 1, with the photo of our designer, Dean, and his large, sharp scalpel? Well he thinks you are a modern twee affectation, and he's coming round to see you!

**Cutting remarks**

Nice to read your issue on 'Better Print', it should help us but we are not sure how!

At the moment we type, edit, and print about 1000 copies (3000 A4 sides) of a news letter each Saturday morning. The dot matrix page is 'scanned' and thus reproduced on an ordinary duplicator 'stencil'.

The result is somewhat fuzzy, and we would like to use LocoScript 2, and/or another printer to produce a more professional print result. Any ideas?

**John Pumphrey  
Enfield, Middx**

Daisywheel printers print in much the same way as typewriters do, and so can cut stencils directly. If you invest in one, at about £300 including a interface unit, LocoScript 2 will drive it directly, and hey presto!

**Spelling it out**

Clearly no spelling-checker can contain a complete dictionary and there are bound to be many words that one will need to add to the ▶



# POSTSCRIPT

User Dictionary. However, why is it that so many simple plurals are missing from LocoSpell? Would it not be possible to refine the programme automatically to take account of words that are pluralised (the spelling-checker didn't like that!) simply by addition of 's' to the end of the word? Or is that so simple it would be fiendishly difficult to achieve?

**A J MacLeod**  
Surrey

*The one crime that is unforgivable in a spelling checker is to pass a word that really is incorrect. English is such a weird language that you can always find exceptions to simple plural rules, so they aren't used.*

## What's in a name?

I was appalled when I first started to try and get into LocoScript – I have rarely seen such a difficult to understand instruction book! However, I found the hints, tips and articles in 8000 Plus extremely

useful. Never have I read a magazine in such detail, or re-read it so frequently. Please keep up the good work.

I very much regret not discovering it earlier and the irony is that I clearly remember seeing it on the shelves months ago – but I never picked it up because of the title. Time after time, whilst looking for a journal to interest and educate me about the PCW machines, I was drawn by mags with the word 'Amstrad' more prominently in the title – and I was repeatedly disappointed.

As a publisher I know the difficulties of choosing a title which is snappy, evocative of the subject and is quite unlike any of your competitors, but I wonder in this instance if, simply for the sake of being different, you haven't picked something a little too remote.

**Silver Link Publishing Ltd**  
Lancs

*Truth be told, various trade mark complications restricted our choice of name. Eagle-eyed readers*

*of issue I might have spotted an alternate name that we were toying with, which accidentally got printed in the TipOffs address. We're thinking of trademarking the word 'Plus', and suing the ancient Greeks for inventing addition.*

## One down

In your January issue you waxed lyrical about Computer One's Typing Tutor. I sent off for this some time ago, but fairly recently had my cheque returned by the firm's receivers. Has anyone else taken over the title, or is it lost forever? I've left it till now to ask, as I hoped there might have been something in February's issue, but no joy. Perhaps you could set your sleuths loose on the problem.

**A V Thurston**  
Tooting, London

*Sherlock Taylor replies: after extensive investigations, it seems that Computer One and its various products are dead and buried. Unless any of you know differently?*

## SCAtterbrain

Your short review of the SCA Serial Interface in the March issue does not mention one important fact. I have seen this interface, it is well made, and works, but it is not hardware compatible with the Amstrad interface, and comes with modified J14CPM3.EMS, MAIL232.COM and other files.

This may cause problems, as many comms programs do not go through the BDOS, but control

the hardware directly, so won't work with this interface. There will also be a problem if a new release of CP/M comes out, or support for the serial port is added to LocoScript. This may not matter for some people, in which case the interface is fine, but it is a point to watch. The documentation does not make this very clear.

**Mr C H Whitford**  
Leicester

*Thanks for the warning. SCA say that they will provide support for any customer who has problems with the SCA interface and specific software.*

## Greenhouse slave

I would like to be able to use my PCW to control the ventilation and irrigation of my greenhouse. Can you tell me if anyone has explored this or similar possibilities? Obviously I would need appropriate hardware as well as the necessary software and would like to know where to get them.

There surely must be many applications where a PCW might be used as the master controller.

**Mr L K Harvey**  
Fareham, Hants

*When microcomputers were young, the magazines were full of articles explaining how you could justify the cost of buying one by using it to control your central heating boiler.*

*The snag is, to use a PCW to control such things, you would need to leave it running 24 hours a day, and it couldn't be used for anything else, like (picking a random example) word processing. It seems a little perverse to tie up £400 of computer in this way – why not just buy a £10 mains timer from Woolworths?*

## Reverential advice

May I, through your column, make a suggestion which might help Rev. John Ticehurst.

The symptoms he describes (of the same old letter appearing every time he creates a new document) indicate him having edited his TEMPLATE.STD file.

Each time a document is Created the PCW picks from disc a copy of TEMPLATE.STD and asks you to name the document (in effect renaming the Template). If the TEMPLATE.STD is Edited, the renaming sequence does not occur and hence, on saving to disc, the newly typed letter has become TEMPLATE.STD.

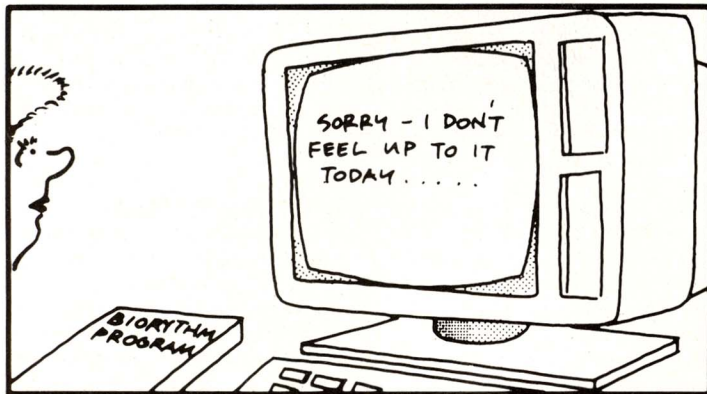

## Tacky tactics

My reason for writing is to express my frustration at the marketing tactics used by some manufacturers and suppliers prominent in the PCW field. I have a couple of specific examples:

1) A powerful command driven wordprocessing program has been heavily advertised in the Journals (including yours) for the past three or four months and was exhibited at the Amstrad Computer Exhibition in London at the beginning of October. When I tried to order a copy I was told that it would not be available for about three weeks, because the Manual had not been completed. Eventually, my copy arrived after the New Year.

2) A very impressive modem was demonstrated at the October exhibition by a Company who also distribute it to a major retailing outlet. Our local branch of the retailer could not obtain the modem for me. Early in the New

Year I ordered it direct from the Company advertising it; my order was not even acknowledged. When I telephoned today (three or four weeks after sending the order) I was told that the modem was out of stock, that they had changed their manufacturers and that they would not even know "for three or four weeks" when the equipment might be available again.

One can perhaps accept that small manufacturers or distributors should not put too much capital into production before making sure that they have enough sales to justify the investment. However in both of these cases the advertising campaign seems to have been professionally designed and is obviously costly. It is therefore difficult not to conclude that the suppliers have engaged in the most cynical exercise of salesmanship, with the sole intention of seeing how many orders they can attract

before thinking about how they might fulfil the orders.

**K J Beach**  
Copley Singletons

*There's a saying in the programming world: 'Badly planned projects take three times as long as you first thought to complete. Well planned ones take only twice as long.' Advertising products before they are ready is certainly not endemic to the PCW – Clive Sinclair has given the phrase 'Allow 28 days for delivery' a whole new meaning.*

*Because of the way magazines work, adverts are typically placed a month before the issues go on sale. The company may reckon it can get everything finished in that month, but delays can occur. I don't think it is so much a cynical attempt to deceive, but that too many marketing men don't allow enough leeway in development time estimates.*



When Creating a new document, TEMPLATE.STD is selected but this now contains the troublesome document.

- I suggest that he:
- 1 Edits TEMPLATE.STD.
  - 2 CUT all text from the document.
  - 3 Resaves document (which will retain the name TEMPLATE.STD).

**L Hornsby**  
Horsforth, Leeds

*You certainly can.*

### Two's company

Owing to problems beyond my control – namely Future Publishing selling out of stock of back copies – I have been unable to get a copy of Issue no. 2 of '8000 Plus'.

I am wondering if there is some kind soul out there in Loco-land, who has finished with that copy, and would be prepared to sell the same to me? I am prepared to pay £1.50 for the privilege, which I think is a fair price, taking in the second-hand value and postage. Please contact me at the address shown.

**Mr M A Cass**  
43 Blackstone Close, Elburton,  
Plymouth PL9 8UQ

*Magazine collectors please note: in years to come issue 2 will rank among the rare modern first editions. Get yours signed by the authors while they are still alive!*

### Sweet and sour

Steady back boys. You are in danger of losing readers; 8000 Plus started off as perhaps the most accessible and comprehensive (to the non-computer buff) of the many Amstrad PCW magazines. But now the magazine is full of program listings and incomprehensible articles.

**Terence Lawton**  
CTL Public Relations

I do appreciate that many readers may not be at a very advanced level of programming or operating and that your magazine provides a useful function even to the likes of myself in many areas. However I am sure that many of your readers would welcome more detailed articles on programming languages.

**Malcolm Moffat**  
Dalmuir, Glasgow

*Ah well, you can't please all of the people all of the time. Some like humorous interludes, some don't. Some like programming articles, some don't. I'm pleased to say that 95% of our correspondents reckon we have struck a good*

*balance, but if you've got any pet likes/dislikes that you would like to see covered or left out, TELL US!*

### Social security

Perhaps you can offer some advice with a couple of applications that I'd like to use. I work in social work and would like to use my PCW 8256 for producing confidential reports on people who receive our service. I believe that the Data Protection Act does not apply to word processors. The problem is that, any reports are likely to be left in Limbo and thus could be accessed by a third party if they knew how to do this. How can this be prevented?

**C Meadows**  
Tooting, London

*For starters, word processors are only exempt from the data protection act as long as you delete the document as soon as you have printed it out. If you store it on disc for future reference, you must register.*

*You can erase Limbo files by first showing them on the screen with the [F8] key and 'Show Limbo' command, and then 'F6 Erase'ing them in the normal way. A real computer whizz could still get at them though – the only totally secure way to erase data is to reformat the disc with DISCKIT (once you've copied all data you want to keep to another disc!)*

### Music while you work

When using my Amstrad I can't listen to the radio as it interferes with reception on all stations.

Can you suggest a remedy short of resorting to the record player?  
**Ashley Pettit**  
London N16

*It's the screen that causes the trouble – you'll find the same problem if you try and listen to a*

### Spoiled Spooler

I would very much like to be able to work on NewWord files while my 8256 printer is busy printing. When I received my copy of Spooler I thought I had the answer.

However, I soon discovered that NewWord is about the only thing it cannot handle.

Now I have received my copy of January's 8000 Plus, after a little postal delay, my hopes are raised again by a Tip-Off which describes how to get round the problem.

After several attempts to follow your instructions I have finally given up. The most constructive comment I can get is "WRONG VERSION OF NWINSTAL FOR THIS NEWWORD!" Since NWINSTAL and WC.COM were

supplied on the same disc this seems a bit unreasonable. I see that NWINSTAL is dated 13 Dec 85 and Word Count is 1981.

If the two programs really are incompatible there must be a lot of people having the same problem. Can you help?

**D T Reeves**  
Collingham, Notts

*Ah. Well. It's like this you see. Our stupid TipOffs editor (er... that's me) systematically mistyped that tip. Wherever you were told to type WC.COM, type NW.COM instead, and the tip will then work. Sorry... I'm just going out to shoot myself.*

*radio with the TV on. Extensive experiments with my own Third World Briefcase have revealed that FM reception is uniformly bad, but if you can make do with AM (medium/long wave) you can get by. You will find that for any station, there is one optimum position for reception. With the PCW on, turn the radio around until the interference is least, and you may be OK.*

### Colourful ideas

The recent advice in your magazine regarding setting out and emphasising letter headings was most useful.

It would be nice however, to produce headed notepaper in various colours. The cassette ribbons on the PCW are very easy to change, so could some kind accessory manufacturer please supply ribbons in Red, Green and Blue, as well as the standard Black?

**A J Crickmere**  
Newmarket

*I don't know of any coloured ribbon cassettes. The only thing you can do is buy an old-fashioned typewriter ribbon (the red-and-black inked cloth kind), cut off a suitable length and glue it into a loop. If you then prise off the top of your PCW ribbon cassette and replace the ribbon, red edge uppermost, you should be able to get red print. Good luck!*

### RPED problems

With reference to your article 'Learn to be an Editor' in the January issue of 8000 Plus, I have encountered two problems.

All went well with using RPED for typing in a listing until the end when on pressing [EXIT] from RPED's main menu I found myself with the A> prompt instead of being in Mallard Basic as suggested in your article. After loading BASIC to correct this and inserting the new program disc and trying to run the program I was faced with the error message 'Direct command found'. The program name included a .BAS file type.

Can you please give me an idea of where I may have gone wrong or how to overcome these problems, the second of which is of course the critical one.

**P B C King**  
Dereham, Norfolk

*If you run RPED directly from CP/M (by typing 'BASIC RPED'), you will be returned to CP/M when you finish. If you load BASIC first of all, and then type 'RUN "RPED";', you will be returned to BASIC afterwards.*

*The 'Direct command found' error means that you have forgotten to type a BASIC line number on one line. Edit the file normally and insert the number.*



"THAT'S INTERESTING – I'VE FOUND OUT I COULDN'T AFFORD THE COMPUTER IN THE FIRST PLACE..."



## ADVERTISERS' INDEX

64 Software Centre ..... 17	HSV Computer Services ..... 40
ASD Peripherals ..... 55	Hewson ..... 49
Advance Software Promotions ..... 53	Juken Enterprises ..... 63
Advanced Memory Systems ..... IFC	Kado ..... 68
Advantage ..... 14	Kintech ..... 82
Amstrad ..... 18,22	Lazahold ..... 39
Ansible ..... 46	Margin Maker ..... 82
Arnor ..... 37,66-67	Mass Business Systems ..... 22
Atlantic Supplies ..... 82	Meridian ..... 68
BBD ..... 71	Mirrorsoft ..... 65
Bradway ..... 68	Nabitchi ..... 4
Campbell Systems ..... 54	Newstar ..... 9
Capitol Marketing ..... 71	Oakridge ..... 82
Cavalier ..... 46	Rational Solutions ..... 68
Cherry Micros ..... 73	Richard Reeves ..... 71
Coleman S C ..... 73	Richmond Software ..... 24
Compumart ..... IBC	SBS ..... 63
Connect Systems ..... 14	Saxon Computing ..... 55
Cornix Software ..... 68	Silicon City ..... 73
Cwmbran Computer Centre ..... 46	Silicon Systems ..... 63
Digita International ..... 53	Softsel ..... OBC
Electric Studio ..... 27	Synergy ..... 40
Focus ..... 55	Tynesoft ..... 50
	The Village ..... 82
	B T Worts ..... 68

## "THE VILLAGE"

**HOUSE OF COMPUTERS**  
**THE Amstrad Specialist in Kent**  
**AMSTRAD PC1512/IBM COMPATIBLE**  
**All Models in stock NOW - Plus**  
**Full range of Software - Ring for details**

### DISCOUNT AMSTRAD PCW SOFTWARE

SAGE	RRP	OUR PRICE	SAGE	RRP	OUR PRICE
Accounts.....	99.95	89.95	Sales Ledger.....	50.00	56.95
Invoicing.....	69.95	63.95	Purchase Ledger.....	50.00	56.95
Payroll.....	69.95	63.95	Invoicing.....	50.00	56.95
Acc. + Inv. + Payroll.....	149.95	139.95	Norm. Ledger.....	50.00	56.95
Chit Chat E-Mail.....	69.95	63.95	Stock Cont.....	50.00	56.95
Chit Chat View.....	69.95	63.95	TASMAN		
Chit Chat Combo.....	99.95	89.95	Tasword 8000.....	24.00	21.95
Retrieve.....	69.95	63.95	ASP		
Magic Filer.....	69.95	63.95	Money Manager.....	20.00	24.95
DIGITAL RESEARCH			At Last Database Manager.....	20.00	24.95
Dr Graph.....	49.95	45.95	CAXTON		
Dr Draw.....	49.95	45.95	Touch 'n' Go.....	24.95	20.95
C Basic.....	49.95	45.95	Brainstorm.....	49.95	42.95
Pascal.....	49.95	45.95	Smartkey.....	49.95	42.95
IANSYST			Scratchpad.....	59.95	59.95
lankeys.....	24.95	21.95	Cardbox.....	59.95	49.95
ARNOR			Condor.....	99.95	84.95
Prospect.....	29.95	26.95	NEWSTAR		
PCW GAMES			Neword.....	59.95	64.95
Batman.....	14.00	12.95	Cracker.....	40.95	43.95
Bridge Player.....	19.00	17.95	MAP		
Cyruss II Chess.....	15.00	12.95	Accounts.....	149.95	129.95
Tomahawk.....	19.00	17.95	Payroll.....	49.95	47.95
Jewels of Darkness.....	19.00	17.95	ASHTON TATE		
Annals of Rome.....	24.95	21.95	D Base 11.....	119.95	114.95
Pawn.....	24.95	21.95	AMSOF		
Trivial Pursuits.....	19.95	17.95	Supercalc 2.....	49.95	43.95
Incom adventures - full range stocked.			Locomail.....	39.95	36.95
Price on application			Locospell.....	39.95	36.95
COMPACT			EDUCATION PCW		
Accounts.....	199.95	179.95	French Mistress.....	19.95	16.95
Daybook.....	40.00	42.95	German Master.....	19.95	16.95
Payroll.....	90.95	84.95	Spanish Tutor.....	19.95	16.85
Nucleus.....	90.95	84.95	DIGITA (formerly Gemini)		
Interface.....	60.95	56.95	Datatore.....	39.95	34.95
			Supertype.....	29.95	24.95

### TRAINING COURSES NOW AVAILABLE

#### ON ALL SOFTWARE & HARDWARE. RING FOR DETAILS

Mail Order welcome. Orders over £50 carriage free, under £50 add £1.50

ACCESS & VISA WELCOME. Up to £1,000 instant credit (A.P.R. 31.3%) - Subject to status

87 Beckenham Lane, Shortlands, Bromley, Kent BR2 0DN Tel: 01-460 7122

## ££ LOOK & SAVE ££

SPECIALIST SOFTWARE PCW			
Accountants	Dentists	Doctors	Draughtsmen
Estate Agents	Farmers	Newsagents	Publicans
Retailers	Solicitors	Technical Authors	Video Rental
STANDARD SOFTWARE PCW			
<b>SAGE</b>	<b>CAMSOFT</b>	<b>VARIOUS</b>	<b>WORDPROCESSING</b>
Pop. Accounts ..... 69.00	Nominal ..... 37.00	MicroSIx Accounts ..... 79.00	Protext ..... 59.00
Pop. Accounts+ ..... 105.00	Payroll ..... 37.00	DR Draw ..... 37.00	New Word 2 ..... 54.00
Pop. Invoice ..... 49.00	Stock ..... 37.00	DR Graph ..... 37.00	Locomail ..... 31.00
Chit. Chat Com ..... 70.00	Invoice ..... 37.00	At Last (DBM) ..... 25.00	LocoSpell ..... 31.00
Ditto w. Modem ..... 191.00	Combe PSIL ..... 112.00	Touch'n Go ..... 19.00	Tasword 8000 ..... 19.00
<b>DATABASES</b>	<b>SPREADSHEETS</b>	<b>LEISURE</b>	<b>LEISURE</b>
DBase II ..... 85.00	Supercalc 2 ..... 39.00	Cyrus 2 Chess ..... 13.95	Bridge Player 3 ..... 17.95
Delta 1.25 ..... 74.00	Scratchpad+ ..... 45.00	Colossos 4 Chess ..... 17.95	Batman ..... 12.95
Condor I ..... 74.00	Cracker 2 ..... 39.00	3D Clock Chess ..... 12.95	Tomahawk ..... 14.50
	<b>COMPUTERS</b>		
	PCW8256/8512 ..... £428.535	PC1512 SD MM 20MB HARD DISC ..... £975	
	PC1512 ..... *CALL for 1987 PRICES	PC1512 SD CM 20MB HARD DISC ..... £1175	

ALL PRICES INCLUDE VAT & DELIVERY  
 DEMONSTRATIONS, QUOTATIONS, CONSULTATION, PERSONAL EXPORT SERVICES.

KINTECH COMPUTERS, ST. TUDY, BODMIN, CORNWALL, PL30 3NH.  
 Tel. 0208 850176

## IMPROVE YOUR IMAGE!

### IMAGE ENHANCING FILTER SCREEN

for Amstrad 8256/8512 monitors.

BANISH glare & flicker.

REDUCE eye strain & headaches.

INCREASE contrast (enhanced image/darker background).

PROLONG tube life (turn the brightness DOWN!).

UNBREAKABLE, non-flam, high grade optical substrate.

SUITABLE for day AND night use.

INSTANTLY attached - no brackets.

SIZE 12" x 10" (254 x 304) mm.

DEVELOPED specifically for 8256/8512 monitors.

5 YEAR UNCONDITIONAL GUARANTEE.

FULL REFUND if not absolutely delighted.

INTRODUCTORY OFFER £6.99 inc. VAT + 60p. post/pkg.

ATLANTIC SUPPLIES, Maenporth, FALMOUTH,  
 Cornwall. Tel: (0326) 250401

## LOCOSCRIPT HELPLINE !

Stuck in a Locoscript rut? Can't make sense of the manuals? HELP IS HERE!

A six monthly subscription to the Helpline entitles you to a total of 3 hours help and advice available at the end of the telephone line.

The Cost? :-

**INTRODUCTORY OFFER ONLY £14.95**

This includes the free assistance with CP/M, BASIC, LOGO and LOCOMAIL and help in producing difficult templates.

INTERESTED? Then contact:-

OAKRIDGE BUSINESS SERVICES  
 on CARDIFF (0222) 761895 for further information

## NEW for PCW!

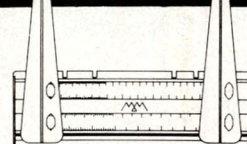

**SINGLE SHEET ALIGNER**  
**'MARGIN MAKER MKII'**

Fed up with skew margins?

Wasting time and paper?

**'MARGIN MAKER MKII' ON YOUR PRINTER WILL GIVE YOU:**

Perfectly aligned printed text & Chosen Header & Footer margins. Any Left margin or paper size. No guesswork. Time & paper savings. Pitch scales 17 15 12 10 aligned to screen. Pencil mark chosen settings. Arms slide then lock. Supports printed sheet. Matches & just clips to PCW printer. Very effective Architect Designed product.

MAKE PRINTING EASIER with a 'MARGIN MAKER MkII' its the COMPLETE answer. Send a self addressed label in BLOCK CAPITALS please, & a Cheque, PO or Money Order payable to:

'MARGIN MAKER',

Box. 121 Gresham Rd, Staines, Middx. TW18 2AJ, England

**£14.95**

incl. VAT & p+p

(Overseas, Sterling £15.95)



# YOU NEED A GOOD SENSE OF HUMOUR TO BUY FROM COMPUMART...

WITH OUR LOW PRICES YOU'LL BE LAUGHING ALL THE WAY TO THE BANK!

**NEW**  
**Low Prices!**

## BOX CLEVER!

BRAND NEW... Specially designed for Amsoft 3"CF2 Disks

**Holds 20-3" Disks & Cases**

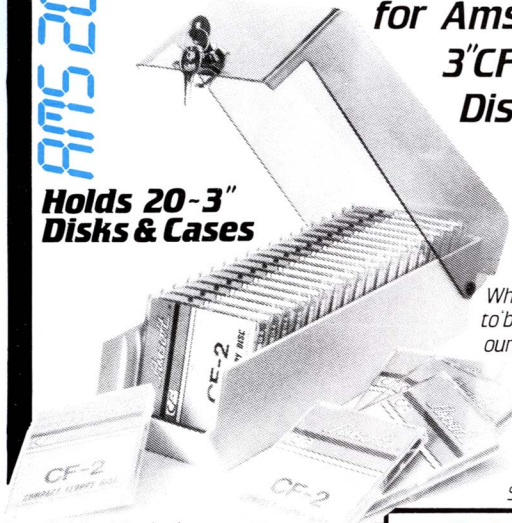

When it comes to 'boxing' you'll find ours a **KNOCKOUT!**  
Excellent quality  
Perspex, lockable.

Save on Accidental Damage from Spilt Drinks-Dust, etc.

**ONLY**  
**£9.95**  
Post Free!

## Amsoft 3" CF2 MICRODISKS

From the U.K.'s LARGEST Supplier

Individually packed in Plastic Cases - Boxed in 5's or 10's

**ONLY 5-£14.95** **ONLY 10-£26.95**  
PACK +£1 p&p / PACK +£1 p&p  
SAVE £3



Phone for Quantity Discounts

New From AMSOFT  
**'LOCOMAIL'**  
For PCW Machines  
Latest version of Locoscript  
with Superb Mailmerge Facility

**Special Software Offer!**  
**ONLY**  
**£39** POST FREE

Buy Now & get  
2 Blank Disks FREE

**Printer Ribbons**  
for  
PCW-8512/8256  
DMP-2000/3000

**ONLY... £4.95 each**  
post Free!

Please specify printer when ordering

ALL Products are covered by the Compumart Guarantee!

### How to Order...

Simply post your order stating: Name and Full Address, with either a Cheque or Postal Order (Made payable to Compumart) to the address opposite.

Phone any of our 3 Order Lines (24 Hours) and place your order using your Credit Card.

All Disks are usually despatched SAME DAY by First Class Post.

For a SPEEDY NEXT DAY Securicor Delivery, just add £2 to Postage (e.g. £3 p&p, add £2... Send £5)

Overseas Orders: Please deduct 15% (VAT), then add 10% (for Air Mail and Insurance).

We accept Official Purchase Orders from Government and Educational Establishments.

# COMPUMART

A GREAT DEAL MORE - FOR A GOOD DEAL LESS!

**3 ORDER LINES**  
(OPEN FOR 24 HOURS)  
☎ ☎ ☎ 262259  
**(0509)** 233893  
266322

Please Send Cheques/P.O.'s to...

**COMPUMART - Dept 8000 + Unit 8 - Falcon Street**  
**Loughborough - Leics - LE11 1EH**

ALL PRICES INC. VAT AT 15%  
PRICES and DELIVERY SUBJECT TO AVAILABILITY





# To boldly drink where no man has drunk before.

If you've ever been served with a cup of tea that resembles canal water. Or begrudgingly sipped a brew with as much taste as a gold lamé string vest, you should be able to sympathize with Arthur Dent.

Star of Infocom's™ hilarious new software extravaganza. The Hitchhiker's Guide to the Galaxy.™

Now programmed for use on the AMSTRAD and a host of other machines "Hitchhikers" gives you the chance to slip into Arthur Dent's shoes and scour the length and breadth of the universe for a decent cuppa.

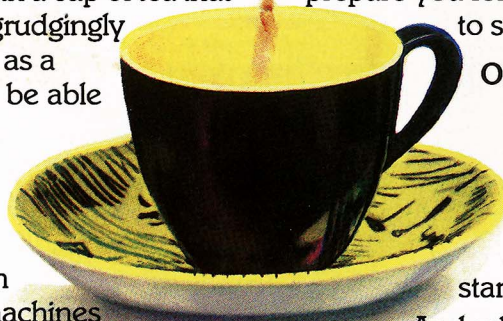

prepare you for a few dangers that are a little harder to swallow.

## ONE LUMP OR TWO

A journey throughout the universe can be a pretty nervewracking business. Especially when there's a whole host of perilous flying saucers, black holes and burning stars to deal with.

And when the Ravenous Buggblatter Beast of Traal asks "Would you like one lump or two?" He's not referring to sugar!

If you sense trouble is brewing you can just zap into another solar system and continue your voyage. But don't forget your towel.

The Hitchhiker's Guide to the Galaxy is available on Earth from your local Softsel dealer. Along with over 2,600 other titles from over 250 publishers.

So don't just sit there stewing — Go and cause a stir in the galaxy.

The Hitchhiker's Guide to the Galaxy — It's out of this world.

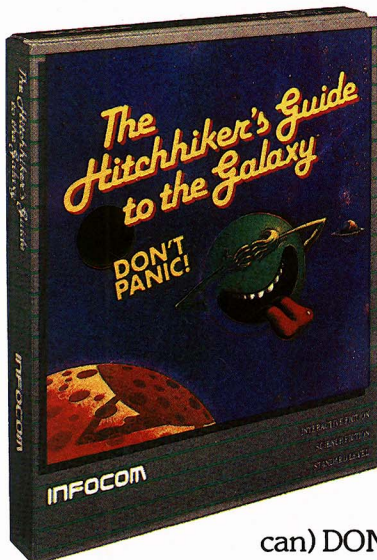

## DON'T PANIC

Gulp with excitement when your planet is demolished by ruthless galactic hyper-space planners.

And split your sides as your home is bulldozed by the local council. You'll laugh so much, it'll bring the house down.

Whatever happens (and just about anything can) DON'T PANIC! For all this will

**SOFTSEL**®

Exclusive distributor of

INFOCOM™

'CLASSICS'

Softsel Computer Products Ltd, Softsel House, Syon Gate Way, Great West Road, Brentford, Middlesex TW8 9DD.